

BV3S/4S-Series Sanitary Multi-Port Ball Valve

The BV3S/4S-series sanitary multi-port ball valve can be used for diversion or control of processing fluid

They are found in the food processing, beverage, winery, brewery, pet product, and industrial markets

Sizes

- 1/2", 3/4", 1", 1-1/2", 2", 2-1/2", 3", 4"

Features

- Live-loaded stem packing
- Integral ISO 5211 mounting pad
- Lockable handle can prevent accidental actuation
- Standard internal entry blow-out proof stem design
- Precision stainless steel balls reduce torque and friction losses while extending shelf life
- Full port design on 1/2" through 3" and reduced port design on 4"
- Compact design for areas with tight space restrictions
- Fully encapsulated construction produces bubble tight seal
- Identification tagging available
- Balanced encapsulated construction minimizes cold flow

Materials

- Product contact metal components: CF8M
- Non-product contact metal components: 304 stainless steel
- Product contact seals: virgin PTFE, 15% reinforced PTFE, UHMW polyethylene, 50% stainless steel reinforced PTFE, 25% carbon reinforced PTFE

Specifications

- Standard connections: clamp
- Valve data
 - Maximum pressure
 - 1/2" to 2": **1000 PSI WOG**
 - 2-1/2" to 4": **800 PSI WOG**
- Surface finish
 - Product contact metal components: ≤ 32 Ra
 - Non-product contact metal components: as cast or $Ra \leq 63$
 - Seat lubricant: BESSI F-100
 - Stem lubricant: G.A. BESSIL 25



BV3S/4S-Series Multi-Port Sanitary Ball Valve - Part Number Key

BV3S/4S-Series Multi-Port Sanitary Ball Valve Part Number Key Example: BV3SVTF050C-A		Valve Style	Seat Material	Ball Configuration	Port Size	Size	Connections		Handle	Surface Finish
		BV3S	V	T	F	050	C	-	A	
Valve Style	Code									
3-way	BV3S	←								
4-way	BV4S									
Seat Material	Code									
Virgin PTFE	V	←								
15% glass reinforced PTFE	G									
25% carbon reinforced PTFE	C									
50% stainless steel reinforced PTFE	S									
Ultra high molecular weight polyethylene	U									
Ball Configuration	Code									
T Port	T	←								
L Port	L									
Port Size	Code									
Full port	F	←								
Reduced port (4" only) ¹	R									
Size	Code									
1/2"	050	←								
3/4"	075									
1"	100									
1-1/2"	150									
2"	200									
2-1/2"	250									
3"	300									
4"	400									
Connections	Code									
Clamp (standard)	C	←								
Weld	B									
Female I-Line	F									
Male I-Line	M									
Threaded Bevel	T									
Plain Bevel with Nut	P									
Q-Line	Q									
John Perry Plain with Nut	J									
John Perry Threaded	H									
Handle	Code									
Manual Handle	A	←								
Surface Finish	Code									
32 Ra I.D.	blank	←								
25 Ra I.D.	-2									
20 Ra I.D.	-1									
15 Ra I.D.	-4									
10 Ra I.D.	-7									

¹Reduced port size is 3.15".

BV3S/4S-Series Actuated Ball Valve - Part Number Key

BV3/4S-Series Actuated Ball Valve Part Number Key Example: BV3SVTF050C-A		Valve Style	Seat Material	Size	Connections	Surface Finish
		3CL	V	50	C	A
Valve Style	Code					
3-Way L-Port	3CL	←				
3-Way T-Port	3CT					
4-Way L-Port	4CL					
4-Way T-Port	4CT					
Seat Material	Code					
Virgin PTFE	V	←				
RTFE (15% glass reinforced PTFE)	G					
25% carbon reinforced PTFE	C					
50% stainless steel reinforced PTFE	S					
UHMW	U					
Size	Code					
1/2"	50	←				
3/4"	75					
1"	10					
1-1/2"	15					
2"	20					
2-1/2"	25					
3"	30					
4"	40					
Connections	Code					
Clamp	C	←				
Weld	B					
Female I-Line	F					
Male I-Line	M					
Threaded Bevel	T					
Plain Bevel with Nut	P					
Q-Line	Q					
Female NPT	1					
Flange	K					
Surface Finish	Code					
32 Ra	A	←				
25 Ra	B					
20 Ra	C					
15 Ra	D					
10 Ra	E					

Continue number selection by following column 1 or 2 on page 5.

BV3S/4S-Series Actuated Ball Valve - Part Number Key

1. Pneumatic Actuator, Spring Return Manual Handle, or Manual Handle with Feedback				2. Electric Actuator				
Actuator	Feedback	Control	Flow Path	Actuator	Voltage	Option 1	Option 2	Flow Path
1	00	XX	10	E	B	1	1	12
Actuator			Code	Actuator				Code
Aluminum spring return pneumatic rack and pinion			1	Electric				E
Aluminum double acting pneumatic rack and pinion			2	Oversized (1-UP) Electric				F
Stainless steel spring return pneumatic rack and pinion			3	Nema 7 Electric				G
Stainless steel double acting pneumatic rack and pinion			4	Electric with Riser Kit				H
Manual handle			5	Voltage				Code
Dead man spring return handle			6	115VAC				B
Oversized (1-UP) aluminum spring return pneumatic rack and pinion			7	12VDC				C
Technopolymer spring return pneumatic rack and pinion			8	24VAC				D
Oversized (1-UP) aluminum double acting pneumatic rack and pinion			9	24VDC				E
Feedback			Code	220VAC				F
None			00	12VAC				G
Limit switch box, position indicator, (2) SPDT mechanical switches			11	Option 1				Code
Limit switch box, position indicator, (2) switches, magnetic reed SPDT, hermetically sealed, up to SIL3, Exia ready, cULus Class 1/2 Div 1/2			12	None				1
Limit switch box, position indicator, AS-I			13	Torque switches				2
Limit switch box, position indicator, (2) proximity SPDT switches, aluminum Exd IIB certified enclosure			14	4-20 mA input/output modulating controller				3
Limit switch box, position indicator, (2) DPDT mechanical switches			15	Current position transmitter				4
Limit switch box, position indicator, (2) switches, electro mechanical SPDT, silver contacts, up to SIL3, cULus Class 1/2 Div 1			16	Potentiometer				5
Limit switch box, position indicator, inductive proximity P+F NBB2-V3-E2, 3 wire PNP NO			17	Local control unit				6
Limit switch box, position indicator, 4-20ma analog position transmitter			18	Two extra travel cams and switches				7
Limit switch box, position indicator, SPDT proximity, 0.25A @ 120VAC, 0.416A @ 48VDC, resistive			19	Three position cam set				8
Limit switch box, position indicator, 4-20ma analog position transmitter + 2 SPDT mechanical switches			20	Local control unit with lock				9
Stainless steel limit switch box, position indicator, (2) proximity SPDT switches			21	1-5V input/2-10V output modulating controller				A
Control			Code	2-10V input/output modulating controller				B
None			XX	75% duty cycle				C
Single coil solenoid, 120VAC			AA	Relay				D
Single coil solenoid, 24VDC			AB	Four position cam set				E
Single coil solenoid, 12VDC			AC	25% duty cycle (actuator code G only)				F
Single coil solenoid, 220VAC			AD	75% duty cycle (actuator code G only)				G
Dual coil solenoid, 120VAC			AE	Option 2				Code
Dual coil solenoid, 24VDC			AF	None				1
Dual coil solenoid, 220VAC			AG	Torque switches				2
Pneumatic positioner 3-15 PSI input, no feedback			AH	4-20mA input/output modulating controller				3
Pneumatic positioner 3-15 PSI input, (2) SPDT mechanical switches for feedback			AI	Current position transmitter				4

BV3S/4S-Series Actuated Ball Valve - Part Number Key

Pneumatic positioner 3-15 PSI input, 4-20mA for feedback	AJ	Potentiometer	5
Electropneumatic positioner 4-20mA input, no feedback	AK	Local control unit	6
Electropneumatic positioner 4-20mA input, (2) SPDT mechanical switches for feedback	AL	Two extra travel cams and switches	7
Electropneumatic positioner 4-20mA input, 4-20mA for feedback	AM	Three position cam set	8
Electropneumatic positioner 0-10v input, no feedback	AN	Local unit with lock	9
Electropneumatic positioner 0-10v input, (2) SPDT mechanical switches for feedback	AO	1-5V input/2-10V output modulating controller	A
Electropneumatic positioner 0-10v input, 4-20mA for feedback	AP	2-10V input/output modulating controller	B
V200 rotary electropneumatic positioner 4-20mA input, 4-20mA feedback	AQ	75% duty cycle	C
Electropneumatic positioner 4-20mA input, no feedback, Class 1, Div II explosion proof	AR	Relay	D
Single coil solenoid, 24VDC and 24V banjo solenoid valve with Form B plug	AS	Four position cam set	E
Single coil solenoid, 24VDC, AS-1, 2.5W low power	AT	25% duty cycle (actuator code G only)	F
Single coil solenoid, 24VDC, intrinsically safe	AU	75% duty cycle (actuator code G only)	G
Single coil solenoid, 24VDC, pre-wired to limit switch with CORSET (dual keyway, 1/2"-20 UNF mating thread, single ended, straight female connector, 22 AWG PVC, auto color code 2P to 6P cable, 12' length)	AV	Flow Path	Code
Single coil solenoid, 24VDC, explosion proof, Class H coil	AW	Energize A, Energize B	12
Single coil solenoid, 24VAC	AX	Energize A, Energize D	13
V200 rotary electropneumatic positioner 4-20mA input, 4-20mA feedback, Class 1, Div II explosion proof	AY	Energize A, Energize B, Energize D (180)	39
Single coil solenoid, 24VDC, molded LED, ind. form, 2M leads	AZ		
TUFRAM COATED electropneumatic positioner 4-20mA input, no feedback	BA		
V200 rotary pneumatic positioner, (2) REED SWITCH feedback	BB		
Single coil solenoid, 120VAC, explosion proof, Class H coil	BC		
Single coil solenoid, 24VDC, pre-wired to limit switch, 6P male connection	BD		
Non-integral 304 stainless steel NEMA 4/4X 3 position control box, includes 3 manifold mount solenoids time delay relay and terminal strip (3 input control, does not require PLC) 24VDC	BE		
Non-integral 304 stainless steel NEMA 4/4X 3 position control box includes 3 manifold mount solenoids time delay relay and terminal strip (3 input control, does not require PLC) 120VAC	BF		
Flow Path	Code		
Rest A, energize B (spring return)	10		
Rest A, energize D (spring return)	11		
Energize A, energize B (double acting)	12		
Energize A, energize D (double acting)	13		
Rest B, energize A, energize D (spring return, 180°)	14		
Rest B, energize A (spring return)	15		

NOTE: Refer to the flow path codes on the following pages for other available configurations.

BV3S/4S-Series Ball Valve - Flow Path Position Codes

What is a multiport ball valve?

Multiport ball valves, also known as a 3-way and 4-way ball valves, provide an easy solution for applications requiring flow direction control in one valve body. 3-way or 4-way refers to the number of valve-to-application connection points there are.



Dixon® Sanitary offers two variations to the 3-way and 4-way multiport ball valves, "L" and "T" port styles. "L" and "T" refer to the shape of the flow path inside the ball of the valve.



Why is a defined flow path necessary?

Rotating the ball inside the valve will yield different flow paths. The requirements of the application will determine the flow path needed when purchasing an actuated multiport ball valve.

When a multiport ball valve is ordered with a manual handle, adjusting the flow path for the application may be as simple as rotating the valve by hand. However, when a multiport ball valve is actuated, the flow path information is required to ensure the valve and necessary components are built in the proper position to meet the application requirements.

BV3S/4S-Series Actuated Ball Valve - Flow Path Position Codes

Understanding the flow path diagrams

When viewing Dixon Sanitary's flow path code tables, it is important to understand what the diagrams mean. The flow path diagrams are drawn as if the top half of the valve was cut off and you are looking straight down on the cut valve. This view shows the L or T shape inside the ball, the position of the ball, and how many connection points are on the valve. Each position is given a letter designation A, B, C, or D.



Example: This diagram shows a 3-way (3 connection points), L-port ball valve ("L" shaped path inside the ball), currently in position "A" (position designation assigned by Dixon Sanitary).



Example: This diagram shows a 3-way (3 connection points), L-port ball valve ("L" shaped path inside the ball), currently in position "C" (position designation assigned by Dixon Sanitary). This position is essentially a shut-off position for the L-port valve. This position is not possible on a T-port valve.



Example: This diagram shows a 4-way (4 connection points), T-port ball valve ("T" shaped path inside the ball), currently in position "A" (position designation assigned by Dixon Sanitary).

Steps to determine the flow path

1. Determine the core function of the valve
 - Will this valve be used to shut off and divert flow? Change the destination of flow? Mix two sources of flow into one?
2. Determine how many flow positions the valve will need to operate. E.g. diverting between two destinations and a shut off position would be three positions.
3. Determine actuator function
 - First determine the source of power for the actuator. Will this be pneumatically or electrically powered? If pneumatic, does it need to be spring return or double acting? Spring return means if air power is lost, the actuator will rotate the valve back to a predetermined "fail" or "rest" position. Double acting and electric both rotate only when air power or electric power are applied.
4. Select the flow path code from the list of available combinations.

BV3S/4S-Series Ball Valve - Flow Path Position Codes

3-Way L-Port

A



B



C



3-Way T-Port

A



B



C



D



4-Way L-Port

A



B



C



D



4-Way T-Port

A



B

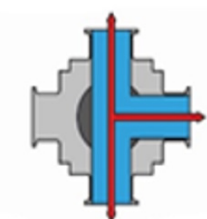

C

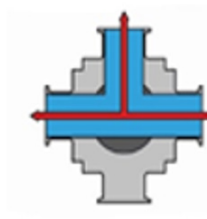

D



BV3S/4S-Series Ball Valve - Flow Path Position Codes

2 Position

3-Way | L-Port | Spring Return

Code	10	16	15	17	18	19
Rotation	90°	90°	90°	90°	90°	90°
Air Rotation Detection	CCW	CW	CW	CCW	CCW	CW
	A	A	B	B	C	C
Rest Position						
	B	C	A	C	A	B
Energize Position						

3-Way | L-Port | Double Acting or Electric

Code	12	20	21
Rotation	90°	90°	90°
	A	A	B
Energize Position			
	B	C	C
Energize Position			

BV3S/4S-Series Ball Valve - Flow Path Position Codes

3-Way | T-Port | Spring Return

Code	10	16	15	11	17	18
Rotation	90°	180°	90°	90°	90°	180°
Air Rotation Detection	CW	Either	CCW	CCW	CW	Either

A

A

B

A

B

C

Rest Position

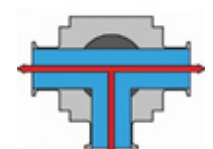
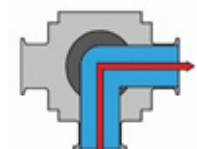
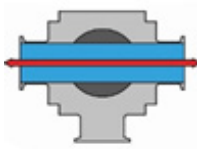
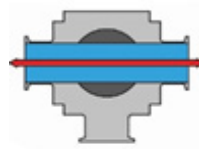
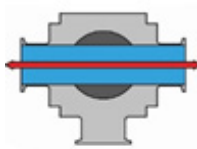

B

C

A

D

C

A

Energize Position

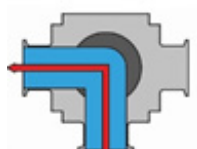
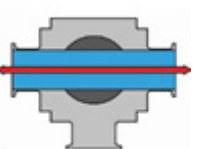
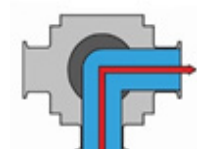

Code	19	22	23	24
Rotation	90°	90°	90°	90°
Air Rotation Detection	CCW	CW	CW	CCW

C

C

D

D

Rest Position

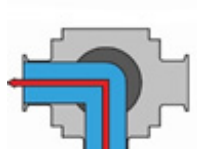
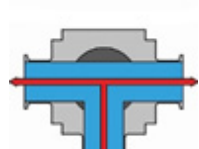

B

D

A

C

Energize Position

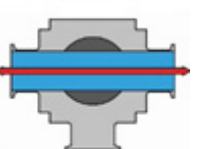
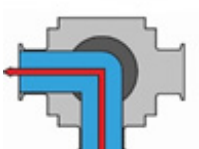
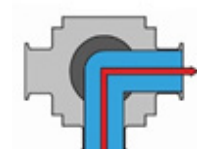

BV3S/4S-Series Ball Valve - Flow Path Position Codes

3-Way | T-Port | Double Acting or Electric

Code	12	20	13	21	25
Rotation	90°	180°	90°	90°	90°
	A	A	A	B	D
Energize Position					
	B	C	D	C	C
Energize Position					

4-Way | L-Port | Spring Return

Code	10	16
Rotation	180°	180°
Air Rotation Detection	Either	Either
Rest Position		
Energize Position		

4-Way | L-Port | Double Acting or Electric

Code	12
Rotation	180°
Energize Position	
Energize Position	

BV3S/4S-Series Ball Valve - Flow Path Position Codes

4-Way | T-Port | Spring Return

Code	10	16	11	15	18	23
Rotation	90°	180°	90°	90°	90°	180°
Air Rotation Detection	CCW	Either	CW	CW	Either	CCW

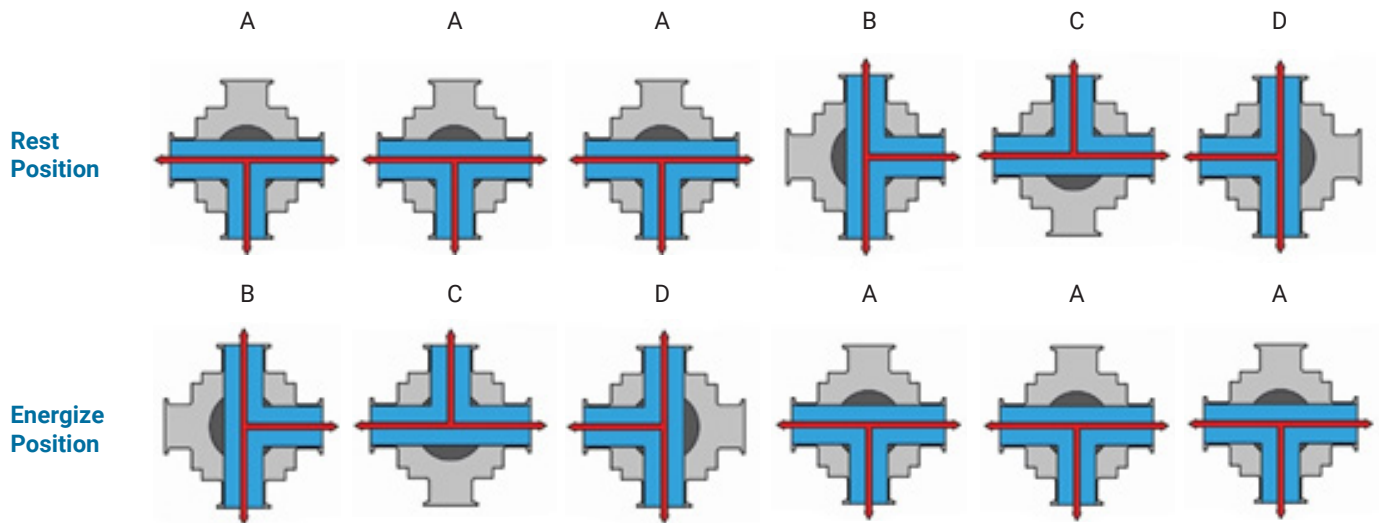

4-Way | T-Port | Double Acting or Electric

Code	12	20	13
Rotation	90°	180°	90°

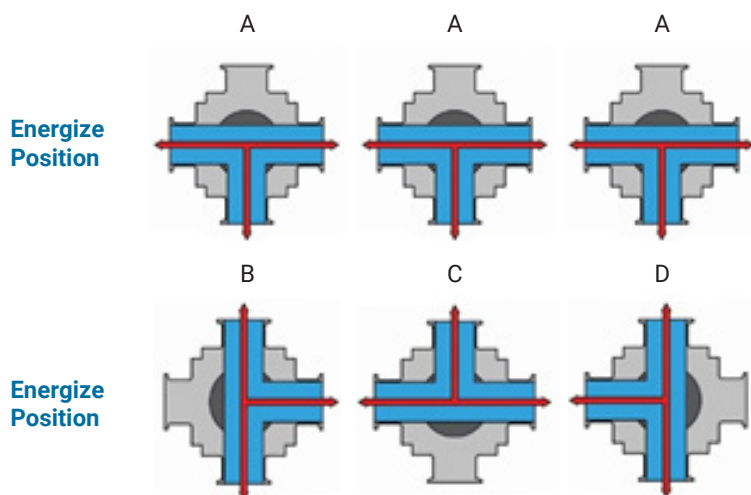

BV3S/4S-Series Ball Valve - Flow Path Position Codes

3 Position

3-Way | L-Port | Spring Return

Code	26	28	29
Rotation	180°	180°	180°
Air Rotation Detection	Either	Either	Either
Return	Either	Either	End

A B C

Rest Position

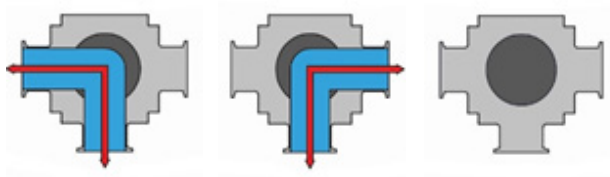

B A A

Energize Position

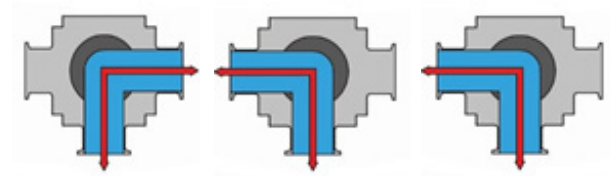

C C B

Energize Position

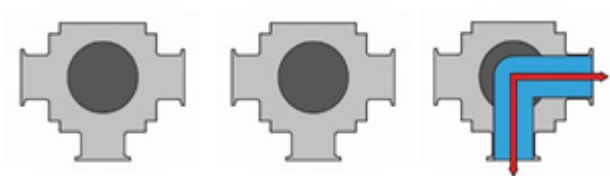

3-Way | L-Port | Double Acting or Electric

Code	30
Rotation	180°

A

Energize Position

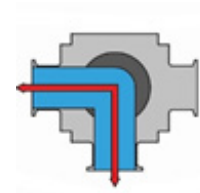

B

Energize Position

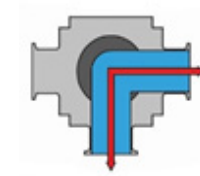

C

Energize Position

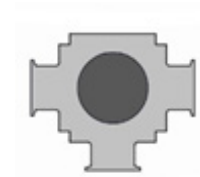

BV3S/4S-Series Ball Valve - Flow Path Position Codes

3-Way | T-Port | Spring Return

Code	26	27	31	28	14	32
Rotation	180°	180°	180°	180°	180°	180°
Air Rotation Detection	CW	Both	CCW	Both	CCW	CW
Return	End	Center	End	Center	End	End

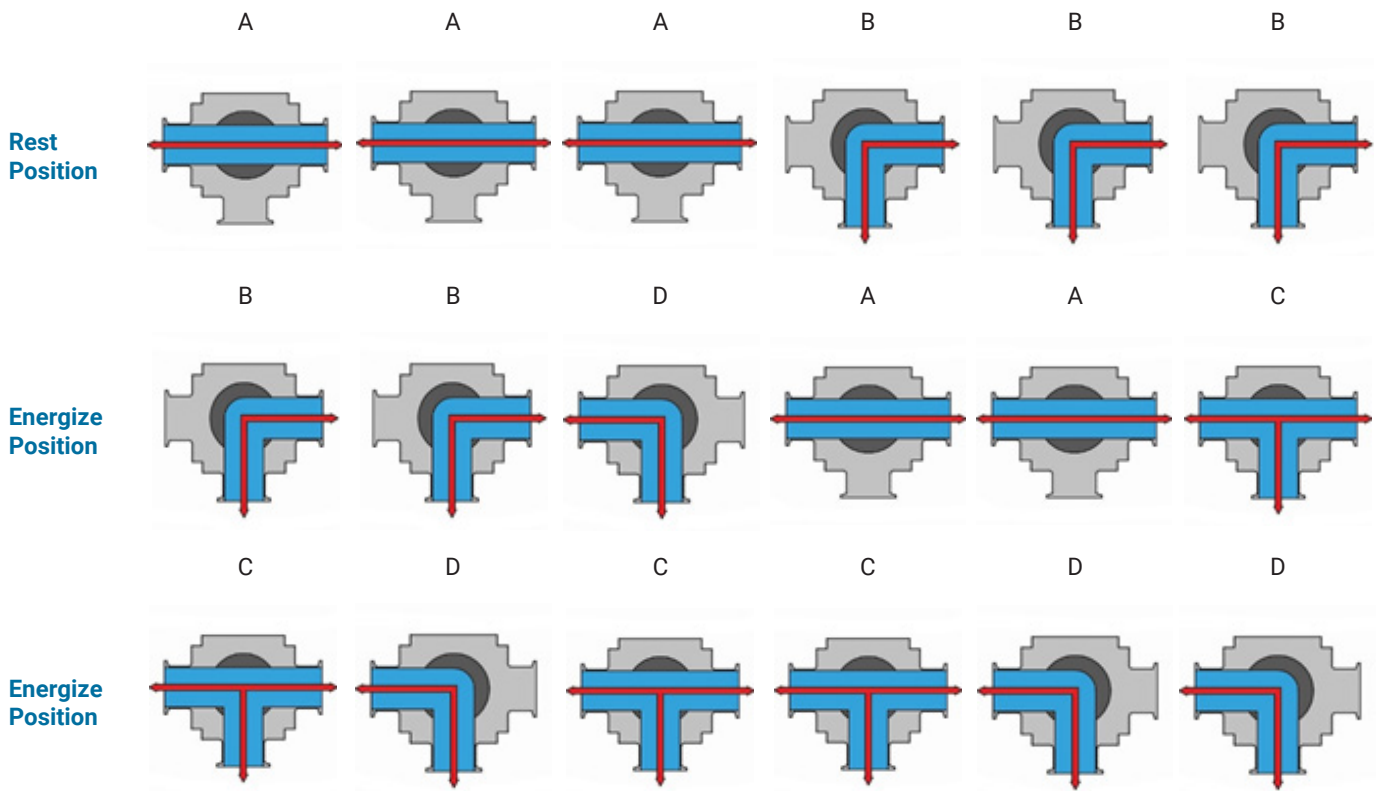

NOTE: 3-way, T-Port, Spring Return continued on the next page

BV3S/4S-Series Ball Valve - Flow Path Position Codes

3-Way | T-Port | Spring Return

Code	33	34	35	36	37	38
Rotation	180°	180°	180°	180°	180°	180°
Air Rotation Detection	CCW	CW	Both	CW	Both	CCW
Return	End	End	Center	End	Center	End

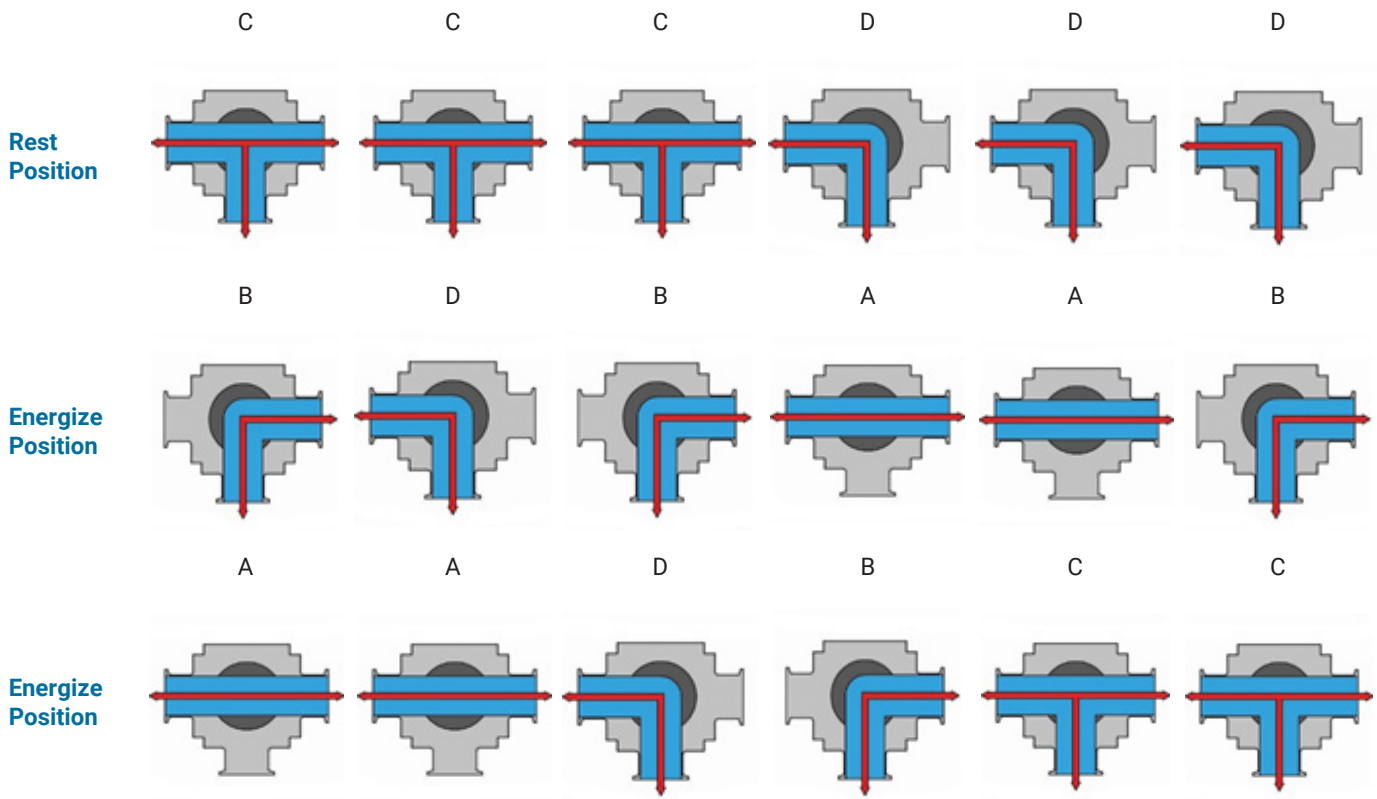

BV3S/4S-Series Ball Valve - Flow Path Position Codes

3-Way | T-Port | Double Acting or Electric

Code	30	39	40	41
Rotation	180°	180°	180°	180°

A

B

A

B

Energize Position

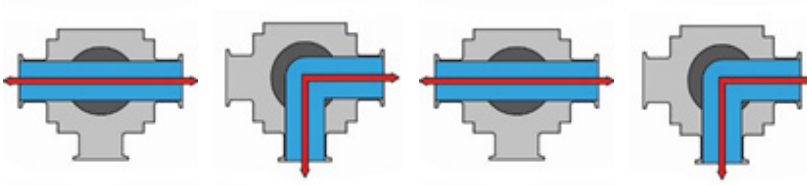

B

A

C

C

Energize Position

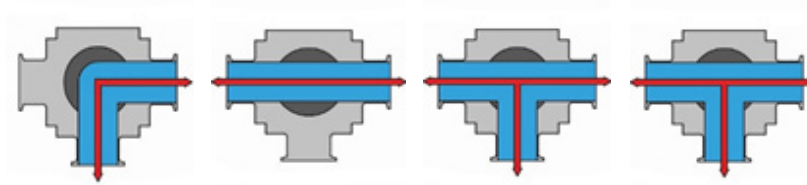

C

D

D

D

Energize Position

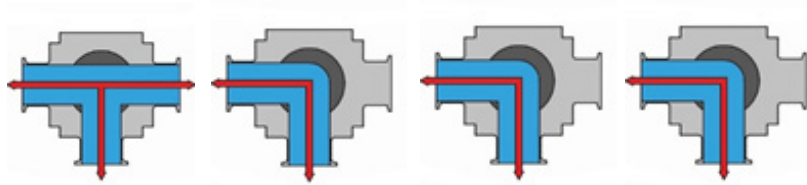

BV3S/4S-Series Ball Valve - Flow Path Position Codes

4-Way | L-Port | Spring Return

Code	26	27	31	28	14	32
Rotation	180°	180°	180°	180°	180°	180°
Air Rotation Detection	CCW	Both	CW	Both	CW	CCW
Return	End	Center	End	Center	End	End

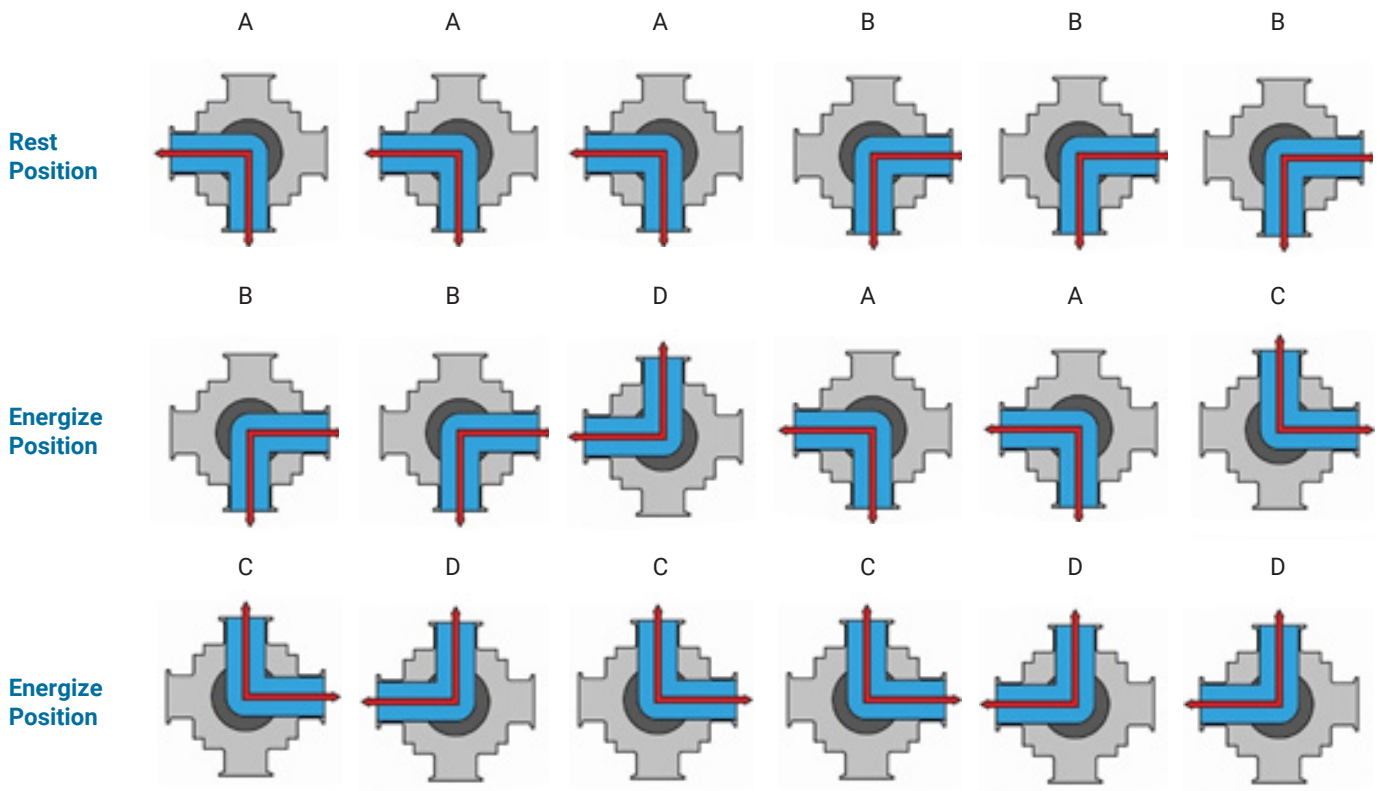

NOTE: 4-way, L-Port, Spring Return continued on the next page

BV3S/4S-Series Ball Valve - Flow Path Position Codes

4-Way | L-Port | Spring Return

Code	33	34	35	36	37	42
Rotation	180°	180°	180°	180°	180°	180°
Air Rotation Detection	CW	CCW	Both	CCW	Both	CW
Return	End	End	Center	End	Center	End

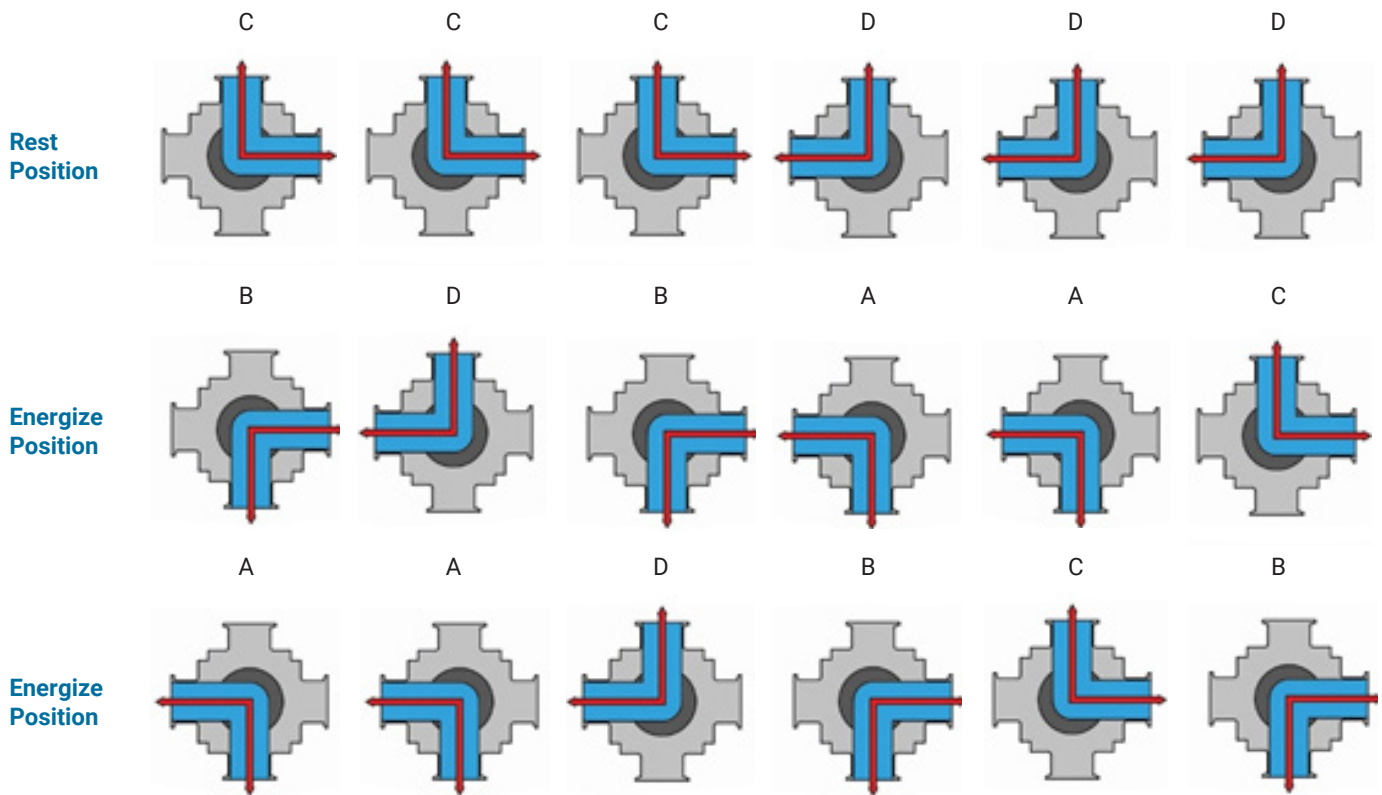

BV3S/4S-Series Ball Valve - Flow Path Position Codes

4-Way | L-Port | Double Acting or Electric

Code	30	39	40	41
Rotation	180°	180°	180°	180°

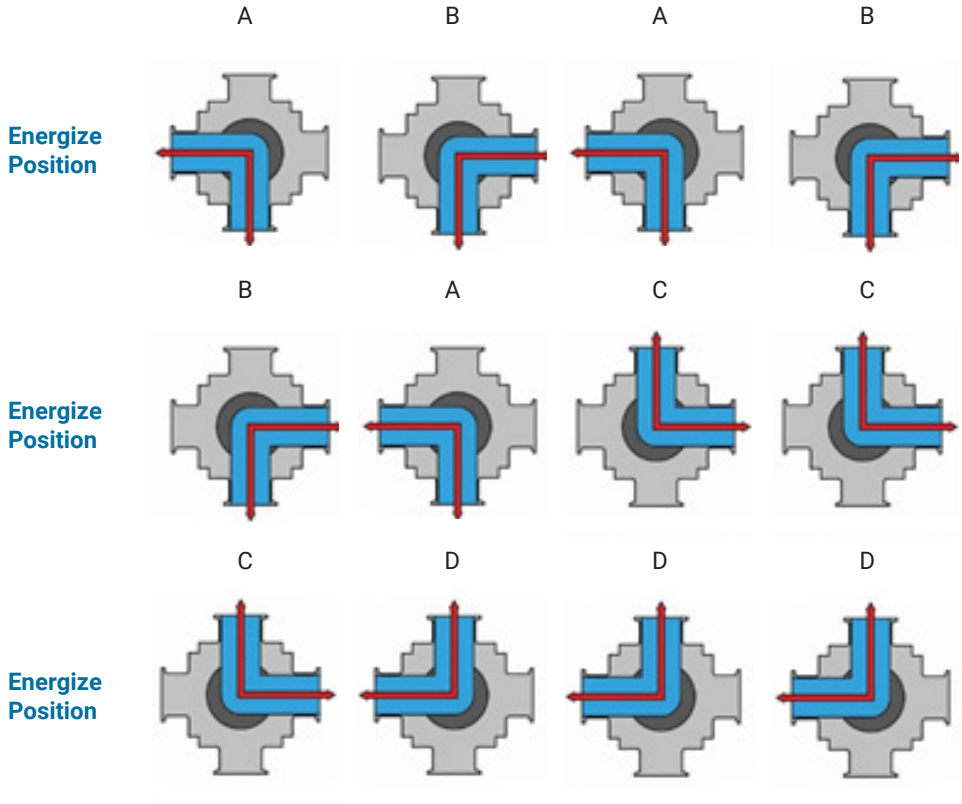

BV3S/4S-Series Ball Valve - Flow Path Position Codes

4-Way | T-Port | Spring Return

Code	26	43	27	28	14	32
Rotation	180°	180°	180°	180°	180°	180°
Air Rotation Detection	CCW	Both	CW	Both	CW	CCW
Return	End	Center	End	Center	End	End

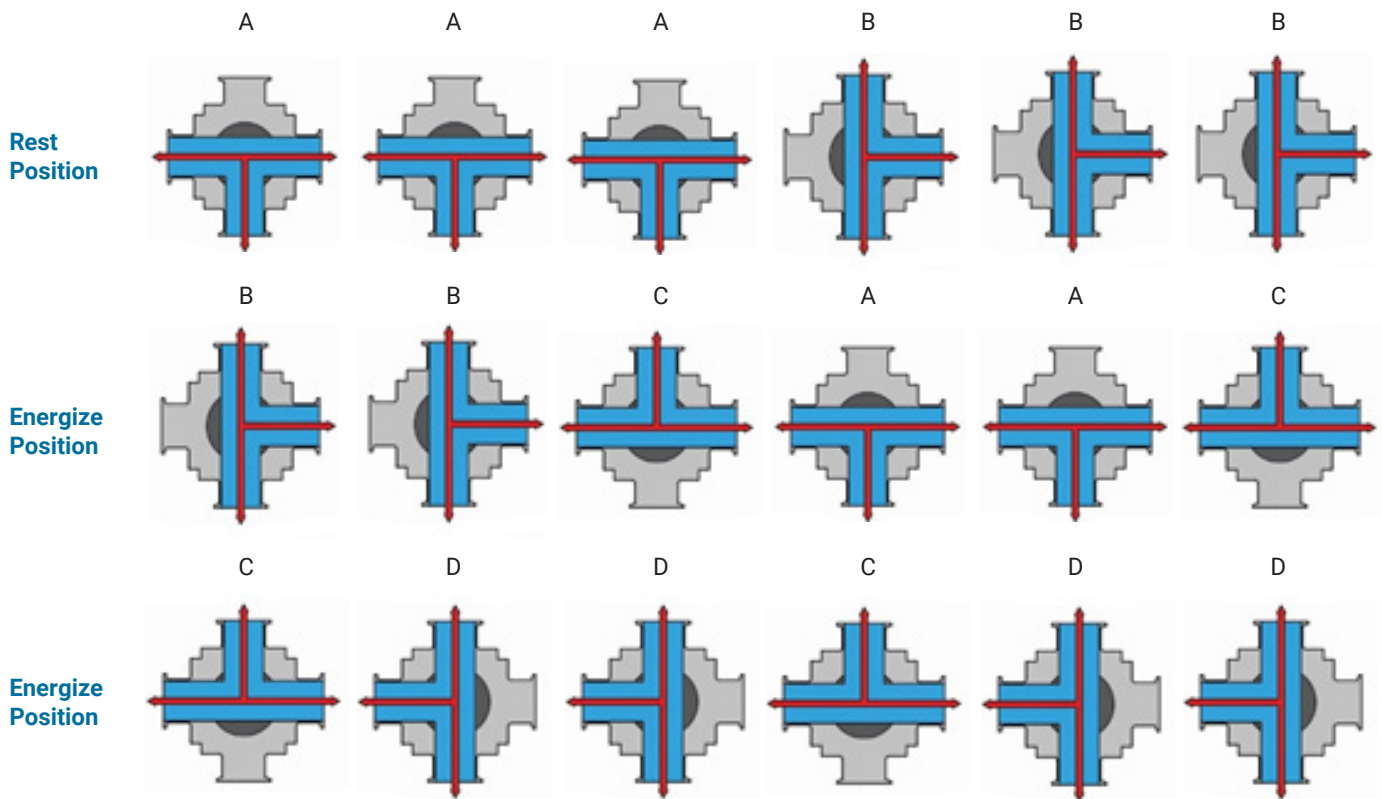

NOTE: 4-way, T-Port, Spring Return continued on the next page

BV3S/4S-Series Ball Valve - Flow Path Position Codes

4-Way | T-Port | Spring Return

Code	33	34	35	36	37	38
Rotation	180°	180°	180°	180°	180°	180°
Air Rotation Detection	CW	CCW	Both	CCW	Both	CW
Return	End	End	Center	End	Center	End

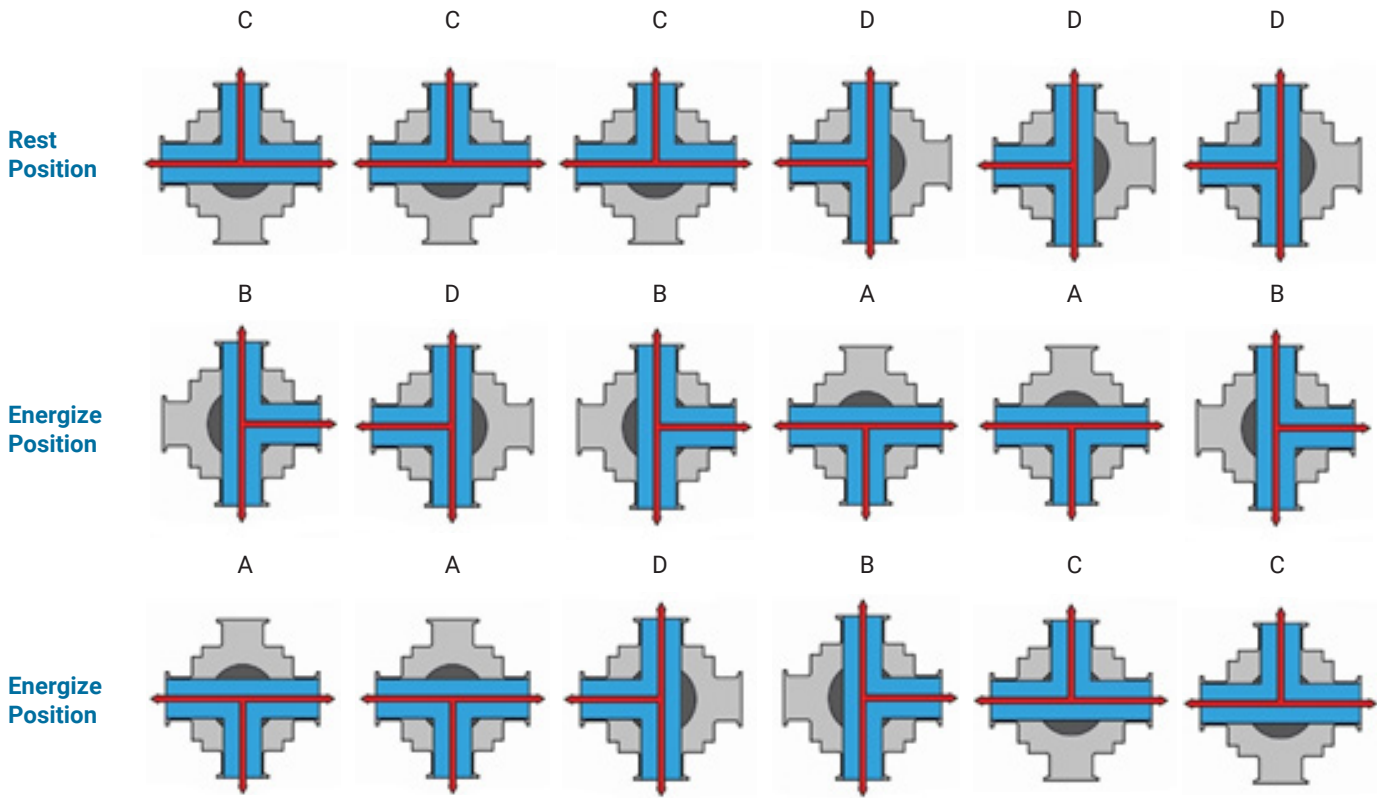

BV3S/4S-Series Ball Valve - Flow Path Position Codes

4-Way | T-Port | Double Acting or Electric

Code	30	39	40	41
Rotation	180°	180°	180°	180°

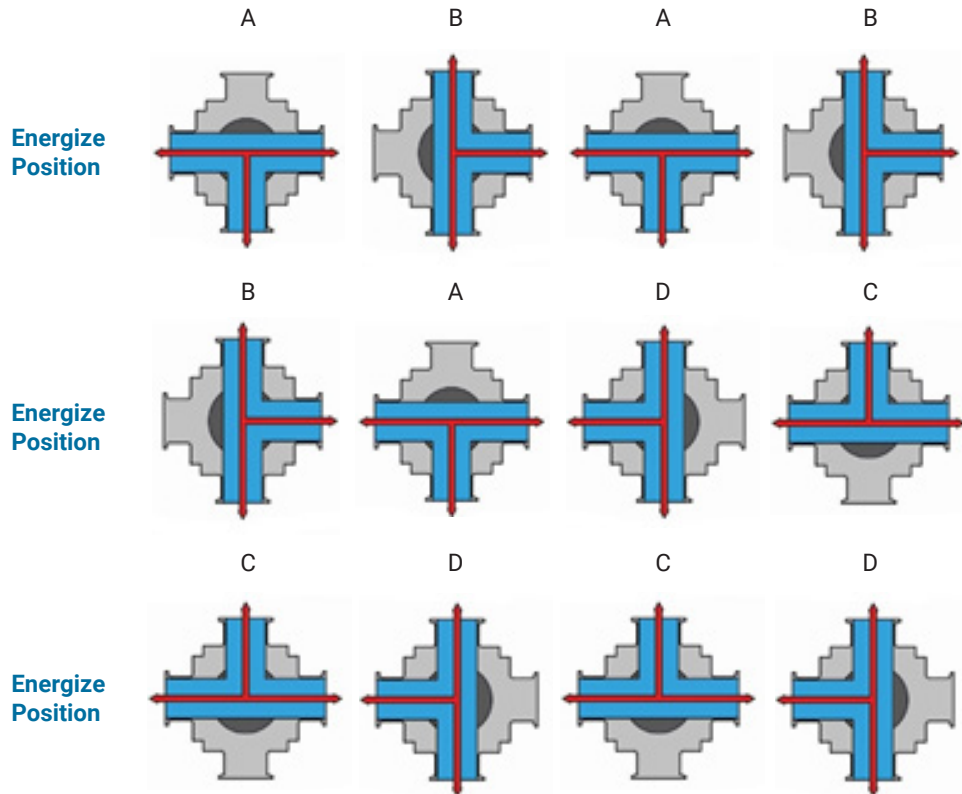

BV3S/4S-Series Actuated Ball Valve - Break Torque

Part #	Size	Base Break Torque (in-lbs)		Flow Coefficient (C _v)			Vacuum Testing (Virgin PTFE Seals)		Weight (lbs)
		L	T	L	T (thru)	T (branched)	Body Leakage (atm-cc/sec)	Helium Leak Rate Test	
BV_S_050_	1/2"	48	45	3.5	5.3	3	1 x 10 ⁻⁹	10 ⁻⁵ Torr	3.6
BV_S_075_	3/4"	62	62	10	14	8			4.3
BV_S_100_	1"	84	79	20	30	14			6.8
BV_S_150_	1-1/2"	315	286	52	80	44			12.6
BV_S_200_	2"	789	595	100	150	83	1 x 10 ⁻⁷	10 ⁻⁴ Torr	21.6
BV_S_250_	2-1/2"	833	1090	148	176	108			33.7
BV_S_300_	3"	1303	1940	250	380	200			56.4
BV_S_R400_	4"	1453	2050	450	680	350			85.4

BV3S/4S-Series Actuated Ball Valve - Seat Multiplier

Code (Seat Material)	Material Torque Multiplier
U (UHMW)	0.9
V (Virgin PTFE)	1
G (15% Glass Reinforced RTFE)	1 (4" = 2.0)
C (25% Carbon Reinforced PTFE)	1.75
S (50% Stainless Steel Reinforced PTFE)	1.75

NOTE: 1) Base Break Torque * Material Torque Multiplier = Material Break Torque

BV3S/4S-Series Ball Valve - Pressure Temperature Charts

0.50 in & 0.75 in

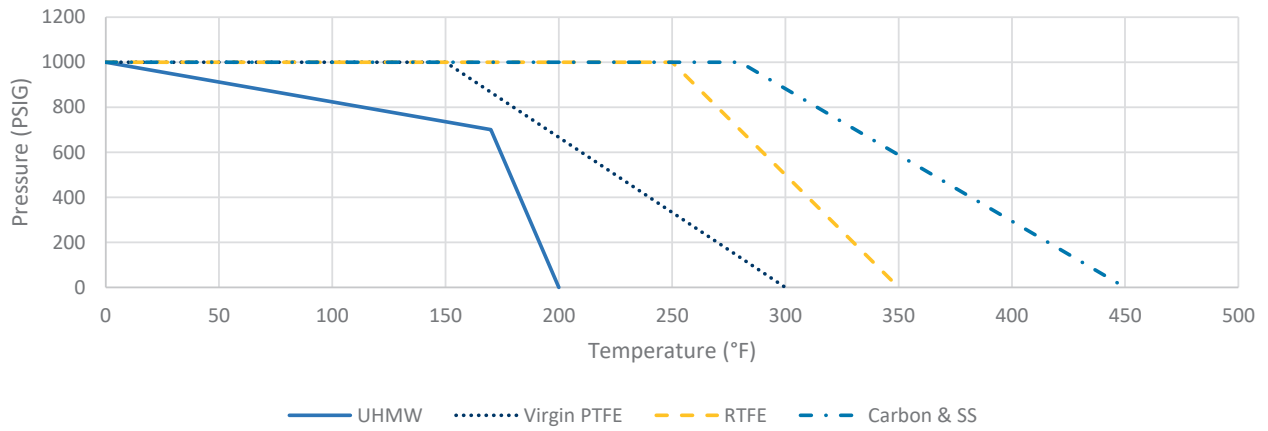

1.00 in

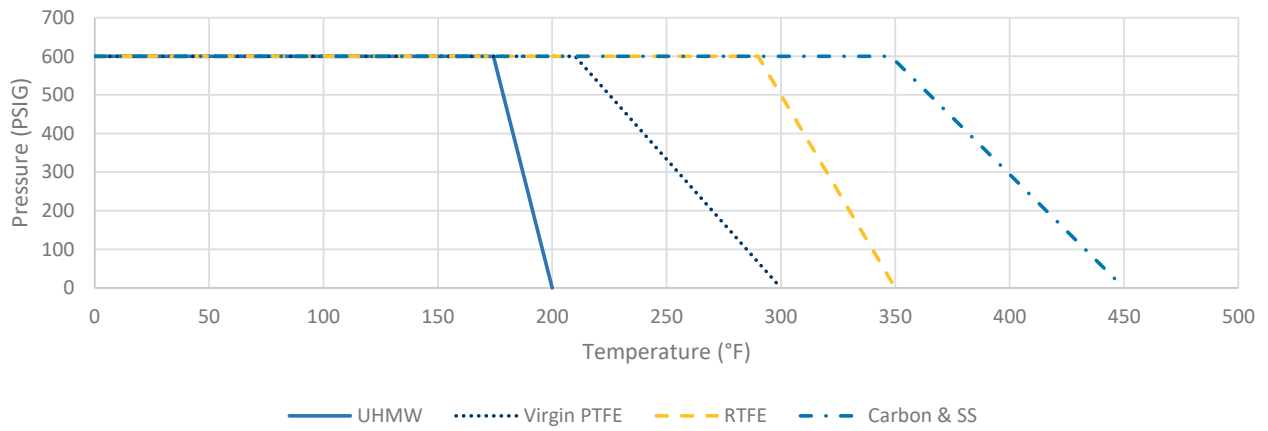

1.50 in & 2.00 in

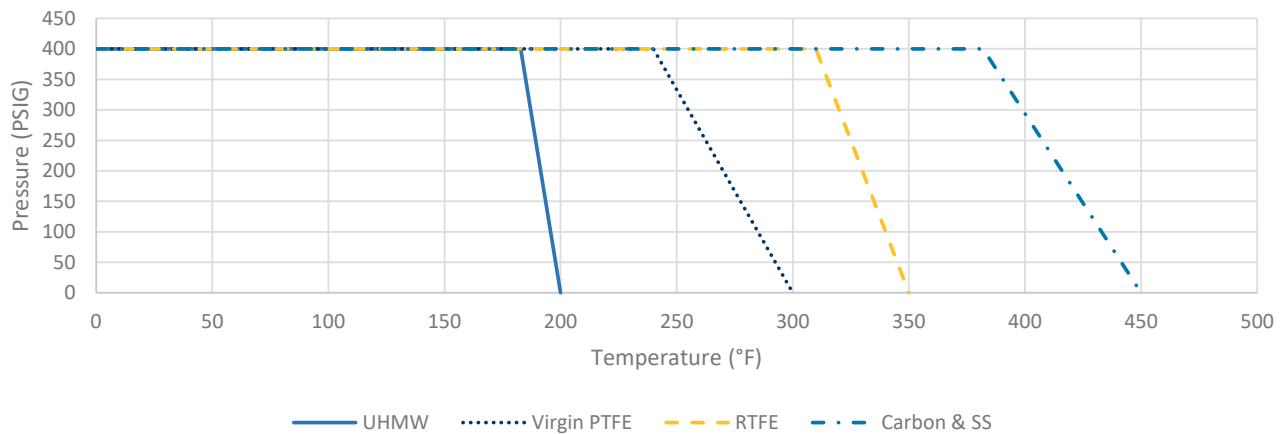

BV3S/4S-Series Ball Valve - Pressure Temperature Charts

2.50 in & 3.00 in

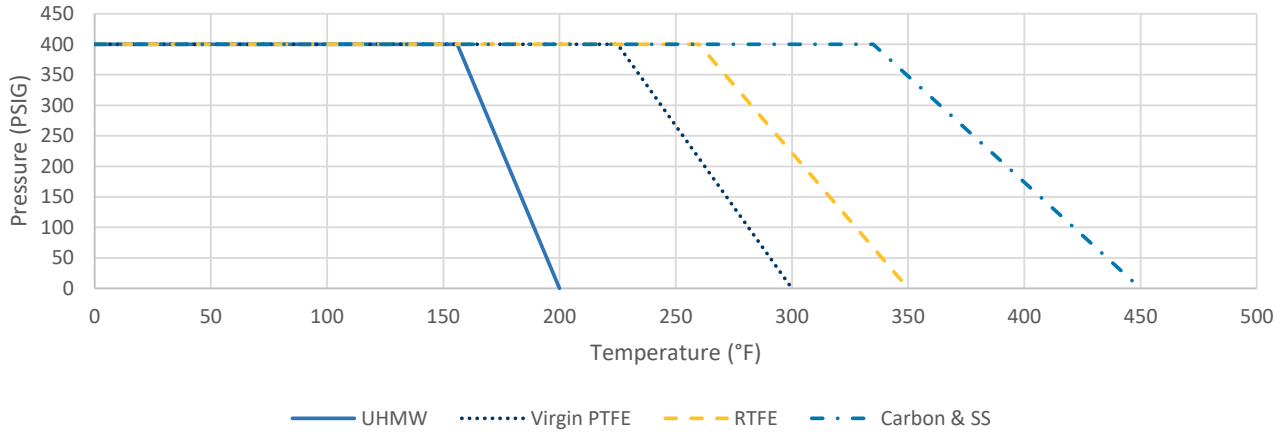

4.00 in

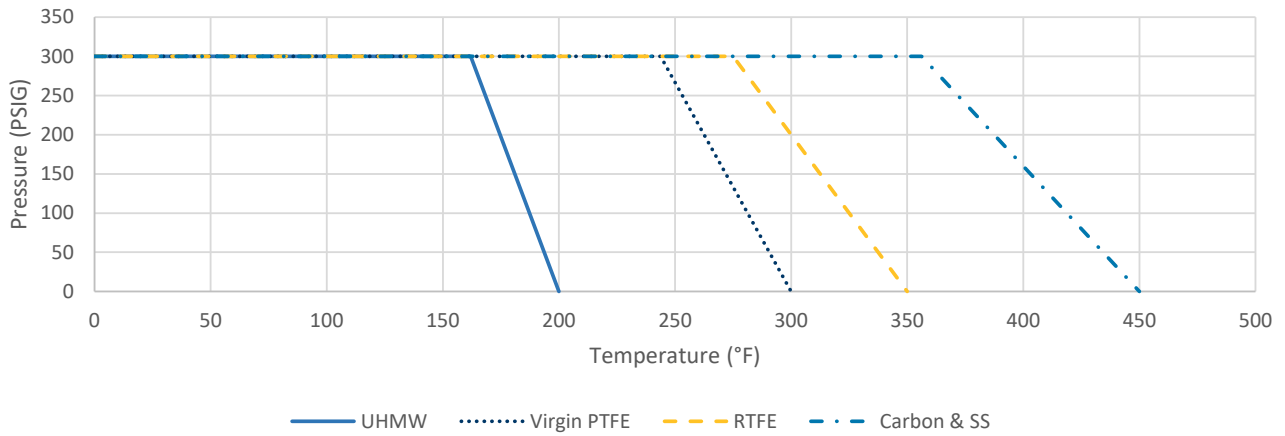

BV3S/4S-Series Ball Valve - Dimensions

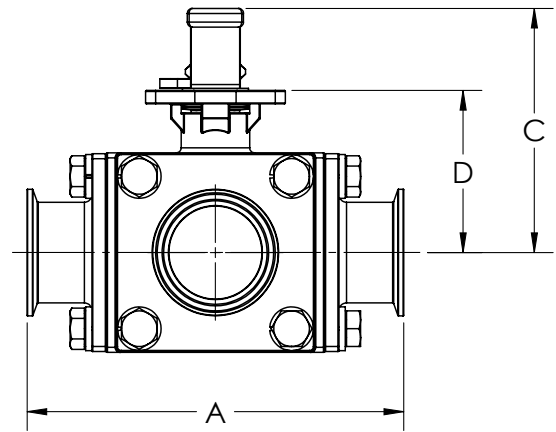
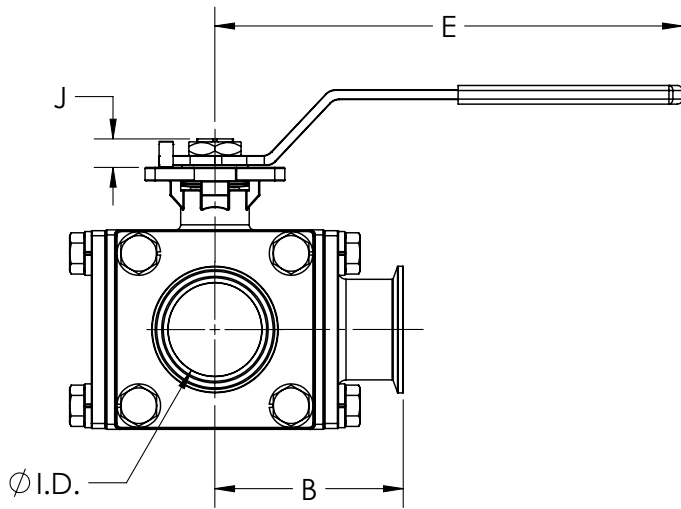
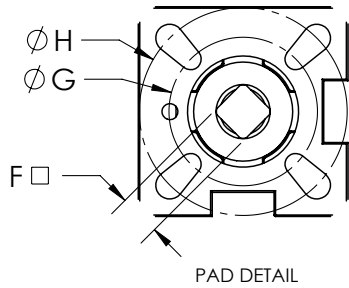





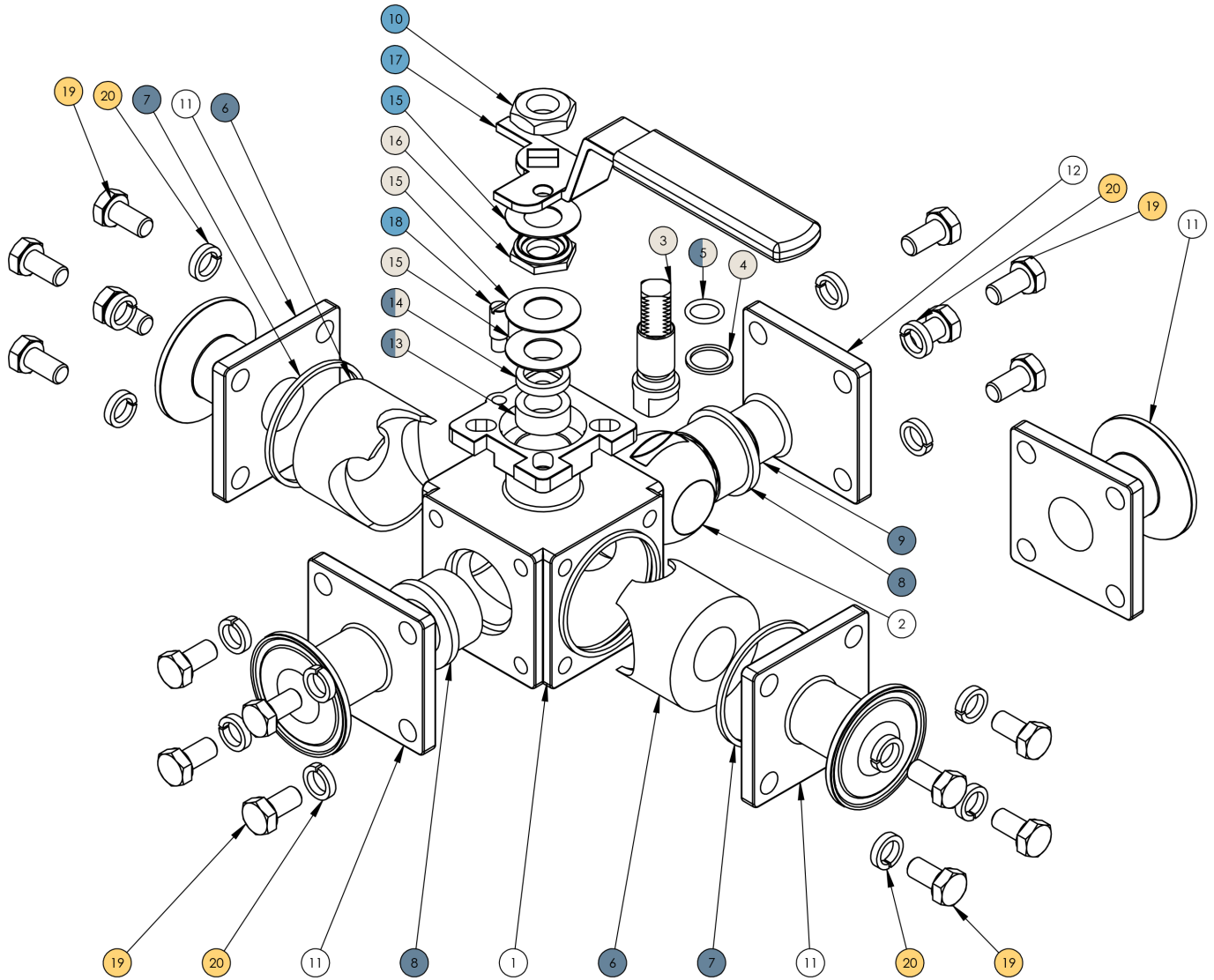













Size	A (in)	B (in)	C (in)	D (in)	E (in)	ID (in)	F (mm)	G (ISO 5211)	H (ISO 5211)	J (mm)
1/2"	4.6	2.3	3.3	1.7	4.9	0.37	9	F03	F04	9
3/4"	5.0	2.5	3.5	1.9	4.9	0.62	9	F03	F04	10
1"	6.0	3.0	3.8	2.3	5.4	0.87	11	F04	F05	12
1-1/2"	6.9	3.4	4.5	2.9	9.3	1.37	14	F05	F07	12
2"	7.5	3.7	4.9	3.2	9.3	1.87	14	F05	F07	14
2-1/2"	8.4	4.5	5.3	3.9	18.0	2.37	17	F07	F10	17
3"	9.6	5.1	6.5	4.9	18.3	2.87	22	F10	F12	24
4"	11.4	6.3	7.0	5.4	18.3	3.83	22	F10	F12	23

BV3S/4S-Series Ball Valve - Bill of Materials (1/2" to 1")



- Included in seat kit (pg 34)
- Included in handle kit (pg 34)
- Included in stem kit (pg 34)
- Included in bolt and nut kit (pg 34) (3-way only)

BV3S/4S-Series Ball Valves - Bill of Materials (1/2" to 1")

Item #	Size	Part #	Description	Material	Qty			
					3-Way		4-Way	
					L-Port	T-Port	L-Port	T-Port
1	1/2"	BV3S-1050	body	CF8M	1	1	1	1
	3/4"	BV3S-1075	body	CF8M	1	1	1	1
	1"	BV3S-1100	body	CF8M	1	1	1	1
2	1/2"	BV-3SVFLB050	L-port ball	CF8M	1	-	1	-
		BV-3SVFTB050	T-port ball	CF8M	-	1	-	1
	3/4"	BV-3SVFLB075	L-port ball	CF8M	1	-	1	-
		BV-3SVFTB075	T-port ball	CF8M	-	1	-	1
	1"	BV-3SVFLB100	L-port ball	CF8M	1	-	1	-
		BV-3SVFTB100	T-port ball	CF8M	-	1	-	1
3	all		stem	304 SS	1	1	1	1
4	all		gland ring	316 SS	1	1	1	1
5	all		stem O-ring	FKM	1	1	1	1
6	all		encapsulated seat	see repair kits	2	2	2	2
7	all		body seal	see repair kits	2	2	2	2
8	all		small encapsulated seat	see repair kits	2	2	2	2
9	all		plug	see repair kits	1	1	-	-
10	all		handle nut	304 SS	1	1	1	1
11	1/2"	BV-3SVFCE050	triclamp end	CF8M	3	3	4	4
	3/4"	BV-3SVFCE075	triclamp end	CF8M	3	3	4	4
	1"	BV-3SVFCE100	triclamp end	CF8M	3	3	4	4
12	1/2"	BV-3SVRCP050	cover plate	CF8M	1	1	-	-
	3/4"	BV-3SVRCP075	cover plate	CF8M	1	1	-	-
	1"	BV-3SVRCP100	cover plate	CF8M	1	1	-	-
13	1/2"		stem packing	see repair kits	1	1	1	1
	3/4"		stem packing	see repair kits	2	2	2	2
	1"		stem packing	see repair kits	3	3	3	3
14	all		thrust washer	see repair kits	1	1	1	1
15*	all		bevel washer	301 SS	3	3	3	3
16	all		stem lock nut	304 SS	1	1	1	1
17	all		handle	304 SS/Vinyl	1	1	1	1
18	all		stop pin	304 SS	1	1	1	1
19	all		bolt	304 SS	16	16	16	16
20	all		lockwasher	304 SS	16	16	16	16





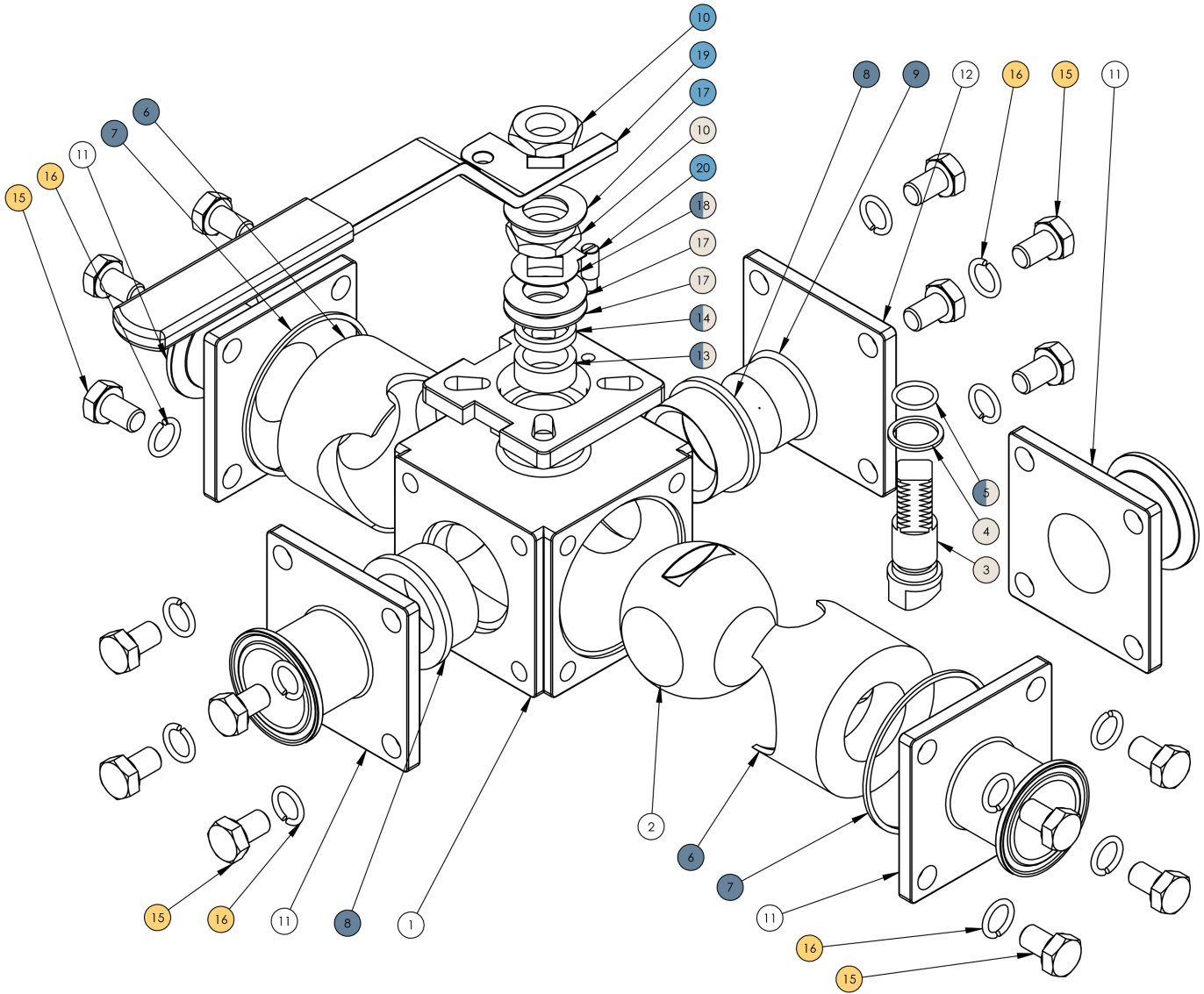











* Top bevel washer is included in the handle kit and the bottom two bevel washers are included in the stem kit.

BV3S/4S-Series Ball Valves - Bill of Materials (1-1/2")



- Included in seat kit (pg 34)
- Included in handle kit (pg 34)
- Included in stem kit (pg 34)
- Included in bolt and nut kit (pg 34) (3-way only)

BV3S/4S-Series Ball Valves - Bill of Materials (1-1/2")

Item #	Part #	Description	Material	Qty			
				3-Way		4-Way	
				L-Port	T-Port	L-Port	T-Port
1	BV3S-1150	body	CF8M	1	1	1	1
2	BV-3SVFLB150	L-port ball	CF8M	1	-	1	-
	BV-3SVFTB150	T-port ball	CF8M	-	1	-	1
3		stem	304 SS	1	1	1	1
4		gland ring	316 SS	1	1	1	1
5		stem O-ring	FKM	1	1	1	1
6		encapsulated seat	see repair kits	2	2	2	2
7		body seal	see repair kits	2	2	2	2
8		small encapsulated seat	see repair kits	2	2	2	2
9		plug	see repair kits	1	1	-	-
10*		stem nut	304 SS	2	2	2	2
11	BV-3SVFCE150	triclamp end	CF8M	3	3	4	4
12	BV-3SVRCP150	cover plate	CF8M	1	1	-	-
13		stem packing	see repair kits	3	3	3	3
14		thrust washer	see repair kits	1	1	1	1
15		bolt	304 SS	16	16	16	16
16		lockwasher	304 SS	16	16	16	16
17**		bevel washer	304 SS	3	3	3	3
18		tab washer	304 SS	1	1	1	1
19		handle	304 SS/Vinyl	1	1	1	1
20		stop pin	304 SS	1	1	1	1

*Top stem nut is included in the handle kit and the bottom stem nut is included in the stem kit.





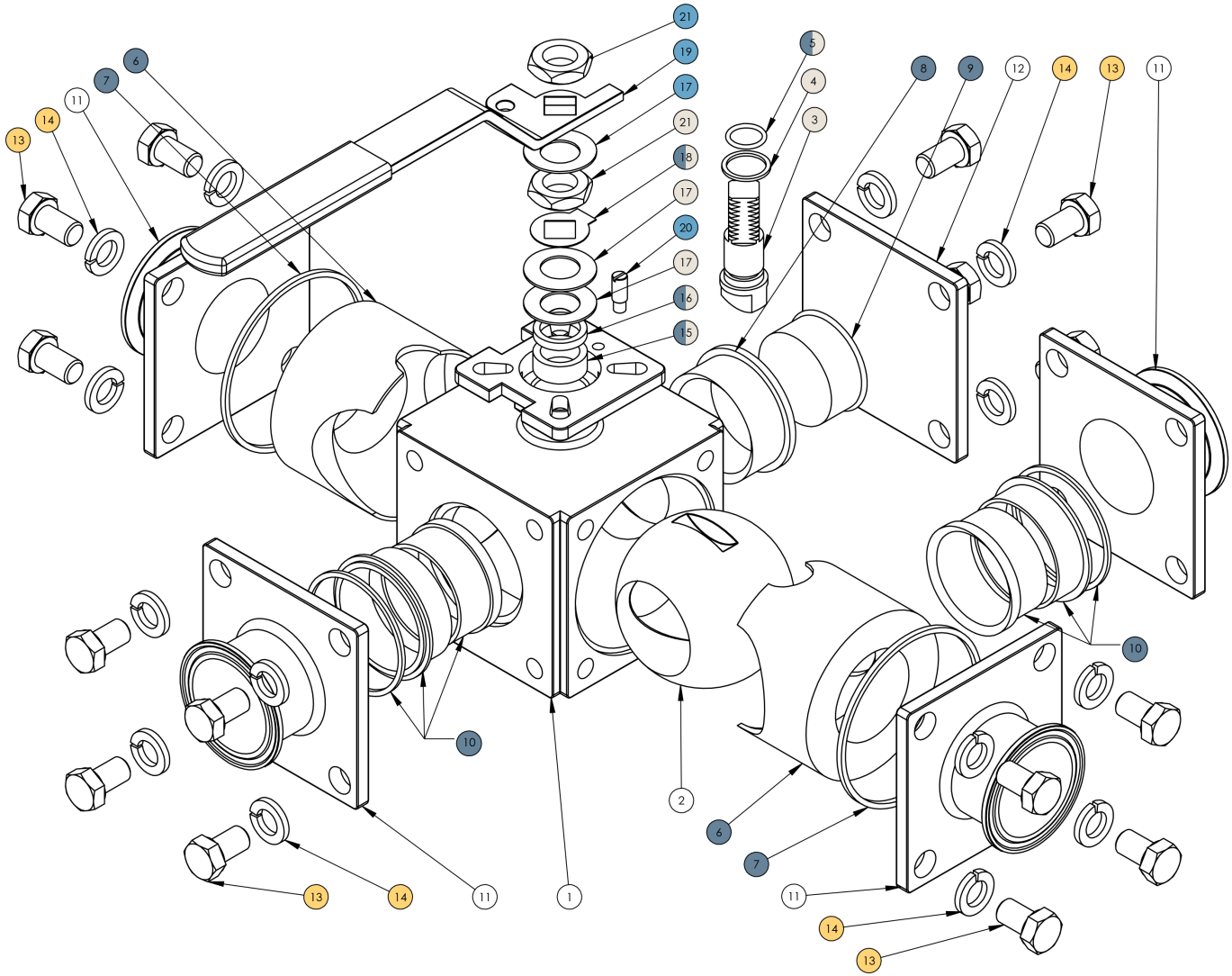











** Top bevel washer is included in the handle kit and the bottom two bevel washers are included in the stem kit.

BV3S/4S-Series Ball Valves - Bill of Materials (2")



- Included in seat kit (pg 34)
- Included in handle kit (pg 34)
- Included in stem kit (pg 34)
- Included in bolt and nut kit (pg 34) (3-way only)

BV3S/4S-Series Ball Valve - Bill of Materials (2")

Item #	Part #	Description	Material	Qty			
				3-Way		4-Way	
				L-Port	T-Port	L-Port	T-Port
1	BV3S-1200	body	CF8M	1	1	1	1
2	BV-3SVFLB200	L-port ball	CF8M	1	-	1	-
	BV-3SVFTB200	T-port ball	CF8M	-	1	-	1
3		stem	304 SS	1	1	1	1
4		gland ring	316 SS	1	1	1	1
5		stem O-ring	FKM	1	1	1	1
6		encapsulated seat	see repair kits	2	2	2	2
7		body seal	see repair kits	2	2	2	2
8		small encapsulated plug seat	see repair kits	2	2	2	2
9		plug	see repair kits	1	1	-	-
10		small seat assembly (3 pcs)	see repair kits	1	1	2	2
11	BV-3SVFCE200	triclamp end	CF8M	3	3	4	4
12	BV-3SVRCP200	cover plate	CF8M	1	1	-	-
13		bolt	304 SS	16	16	16	16
14		lockwasher	304 SS	16	16	16	16
15		stem packing	see repair kits	3	3	3	3
16		thrust washer	see repair kits	1	1	1	1
17*		bevel washer	301 SS	3	3	3	3
18		tab washer	304 SS	1	1	1	1
19		handle	304 SS/Vinyl	1	1	1	1
20		stop pin	304 SS	1	1	1	1
21**		stem nut	304 SS	2	2	2	2

*Top bevel washer is included in the handle kit and the bottom two bevel washers are included in the stem kit.





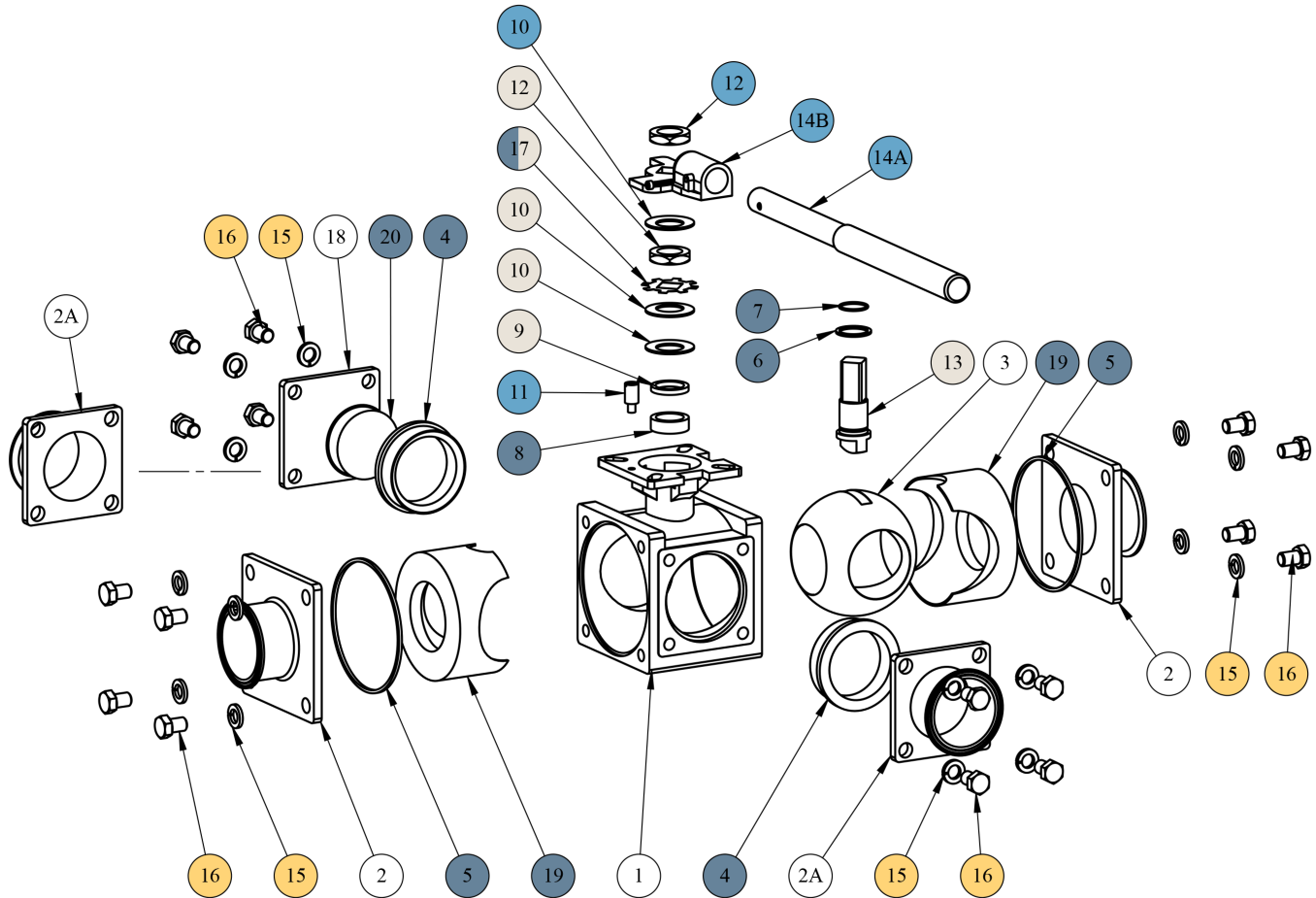















** Top stem nut is included in the handle kit and the bottom stem nut it included in the stem kit.

BV3S/4S-Series Ball Valve - Bill of Materials (2-1/2" to 4")



- Included in seat kit (pg 34)
- Included in handle kit (pg 34)
- Included in stem kit (pg 34)
- Included in bolt and nut kit (pg 34) (3-way only)

BV3S/4S-Series Ball Valve - Bill of Materials (2-1/2" to 4")

Item #	Size	Part #	Description	Material	Qty			
					3-Way		4-Way	
					L-Port	T-Port	L-Port	T-Port
1	2-1/2"	BV3S-1250	body	CF8M	1	1	1	1
	3"	BV3S-1300	body	CF8M	1	1	1	1
	4"	BV3S-1400	body	CF8M	1	1	1	1
2	2-1/2"	BV-3SVFCL250	large triclamp end	CF8M	2	2	2	2
	3"	BV-3SVFCL300	large triclamp end	CF8M	2	2	2	2
	4"	BV-3SVFCL400	large triclamp end	CF8M	2	2	2	2
2A	2-1/2"	BV-3SVFCS250	small triclamp end	CF8M	1	1	2	2
	3"	BV-3SVFCS300	small triclamp end	CF8M	1	1	2	2
	4"	BV-3SVFCS400	small triclamp end	CF8M	1	1	2	2
3	2-1/2"	BV-3SVFLB250	L-port ball	CF8M	1	-	1	-
		BV-3SVFTB250	T-port ball	CF8M	-	1	-	1
	3"	BV-3SVFLB300	L-port ball	CF8M	1	-	1	-
		BV-3SVFTB300	T-port ball	CF8M	-	1	-	1
	4"	BV-3SVFLB400	L-port ball	CF8M	1	-	1	-
		BV-3SVFTB400	T-port ball	CF8M	-	1	-	1
4	all		small encapsulated seat	see repair kits	2	2	2	2
5	all		body seal	see repair kits	2	2	2	2
6	all		thrust washer	see repair kits	1	1	1	1
7	all		stem O-ring	FKM	1	1	1	1
8	all		stem packing	see repair kits	3	3	3	3
9	all		gland ring	316 SS	1	1	1	1
10*	all	 	bevel washer	301 SS	3	3	3	3
11	all		stop pin	304 SS	1	1	1	1
12**	all	 	stem nut	304 SS	2	2	2	2
13	all		stem	304 SS	1	1	1	1
14A	all		handle	304 SS/Vinyl	1	1	1	1
14B	all		handle hub	CF3	1	1	1	1
15	all		lockwasher	304 SS	16	16	16	16
16	all		bolt	304 SS	16	16	16	16
17	all	 	tab washer	304 SS	1	1	1	1
18	2-1/2"	BV-3SVRCP250	cover plate	CF8M	1	1	0	0
	3"	BV-3SVRCP300	cover plate	CF8M	1	1	0	0
	4"	BV-3SVRCP400	cover plate	CF8M	1	1	0	0
19	all		large encapsulated seat	see repair kits	2	2	2	2
20	all		plug	see repair kits	1	1	-	-

*Top bevel washer is included in the handle kit and the bottom two bevel washers are included in the stem kit.

** Top stem nut is included in the handle kit and the bottom stem nut is included in the stem kit.

BV3S-Series Ball Valve - Repair Kit Part Numbers

 **Seat Kits**

Size	Material				
	Virgin PTFE	RTFE	25% Carbon PTFE	50% Stainless Steel PTFE	UHMW
1/2"	BV-3SVFRK050	BV-3SGRK050	BV-3SCRK050	BV-3SSRK050	BV-3SURK050
3/4"	BV-3SVFRK075	BV-3SGRK075	BV-3SCRK075	BV-3SSRK075	BV-3SURK075
1"	BV-3SVFRK100	BV-3SGRK100	BV-3SCRK100	BV-3SSRK100	BV-3SURK100
1-1/2"	BV-3SVFRK150	BV-3SGRK150	BV-3SCRK150	BV-3SSRK150	BV-3SURK150
2"*	BV-3SVFRK200	BV-3SGRK200	BV-3SCRK200	BV-3SSRK200	BV-3SURK200
2-1/2"	BV-3SVFRK250	BV-3SGRK250	BV-3SCRK250	BV-3SSRK250	BV-3SURK250
3"	BV-3SVFRK300	BV-3SGRK300	BV-3SCRK300	BV-3SSRK300	BV-3SURK300
4"	BV-3SVRRK400	BV-3SGRK400	BV-3SCRK400	BV-3SSRK400	BV-3SURK400

*The 3-piece small assembly (2" only) contains (2) seat material components and (1) 316L stainless steel ring.

 **Handle Kits**

Size	Part #
1/2"	BV-23-HA050-075
3/4"	
1"	BV-23-HA100
1-1/2"	BV-23-HA150-200
2"	
2-1/2"	BV-23-HA-17
3"	BV-23-HA-22
4"	

 **Stem Kits**

Size	Part #	
	L Port	T Port
1/2"	BV3SV-SML-050	BV3SV-SMT-050
3/4"	BV3SV-SML-075	BV3SV-SMT-075
1"	BV3SV-SML-100	BV3SV-SMT-100
1-1/2"	BV3SV-SML-150	BV3SV-SMT-150
2"	BV3SV-SML-200	BV3SV-SMT-200
2-1/2"	BV3SV-SML-250	BV3SV-SMT-250
3"	BV3SV-SML-300	BV3SV-SMT-300
4"	BV3SV-SML-400	BV3SV-SMT-400

 **Bolt and Washer Kit (3-way only)**

Size	Part Number
1/2"	BV-3X-BN050
3/4"	BV-3X-BN075
1"	BV-3X-BN100
1-1/2"	BV-3X-BN150
2"	BV-3X-BN200
2-1/2"	BV-3X-BN250
3"	BV-3X-BN300
4"	BV-3X-BN400

Limited Warranty

DIXON VALVE & COUPLING COMPANY, LLC (herein called "Dixon") warrants the products described herein and manufactured by Dixon to be free from defects in material and workmanship for a period of one (1) year from date of shipment by Dixon under normal use and service. Its sole obligation under this warranty being limited to repairing or replacing, as hereinafter provided, at its option any product found to Dixon's satisfaction to be defective upon examination by it, provided that such product shall be returned for inspection to Dixon's factory within three (3) months after discovery of the defect. The repair or replacement of defective products will be made without charge for parts or labor. This warranty shall not apply to: (a) parts or products not manufactured by Dixon, the warranty of such items being limited to the actual warranty extended to Dixon by its supplier; (b) any product that has been subject to abuse, negligence, accident, or misapplication; (c) any product altered or repaired by others than Dixon; and (d) normal maintenance services and the replacement of service items (such as washers, gaskets, and lubricants) made in connection with such services. To the extent permitted by law, this limited warranty shall extend only to the buyer and any other person reasonably expected to use or consume the goods who is injured in person by any breach of the warranty. No action may be brought against Dixon for an alleged breach of warranty unless such action is instituted within one (1) year from the date the cause of action accrues. This limited warranty shall be construed and enforced to the fullest extent allowable by applicable law.

Other than the obligation of Dixon set forth herein, Dixon disclaims all warranties, express or implied, including but not limited to any implied warranties of merchantability or fitness for a particular purpose, and any other obligation or liability. The foregoing constitutes Dixon's sole obligation with respect to damages, whether direct, incidental, or consequential, resulting from the use or performance of the product.

Some products and sizes may be discontinued when stock is depleted or may require a minimum quantity for ordering.

Limits of Liability

This brochure is intended as a product offering. It is not intended to be a user or technical manual. Information in this brochure is subject to change without notice. All users and distributors of products sold through this brochure should contact Dixon with questions of use, compatibilities, coupling procedures, and life of product. Our full-time engineering and test staff are always available to recommend uses and to assist distributors and users with any questions.



Safety



Safety logos, which appear throughout our catalog, are used as a reminder that the user should carefully review for the appropriateness of the product for the media, application, and environment in which it will be used.

NOTE: Because of the health hazards associated with contamination and lead content in drinking water systems, Dixon couplings, unless otherwise specifically approved, are not recommended for potable water service and should not be used in applications where drinking water will contact the wetted surfaces of the coupling.

All Dixon products are shipped in cartons with the following warning:

"WARNING: This product contains lead, a chemical known to the State of California to cause cancer and birth defects or other reproductive harm."

Trademark

Delrin® and Zytel® are registered trademarks of E. I. du Pont Nemours and Company.

Kalrez® is a registered trademark of DuPont Dow Elastomers.

All other trademarks appearing in the Dixon illustrated product list are the property of their respective owners.

Copyright

Copyright © 2025 by Dixon Valve & Coupling Company, LLC

All rights reserved. This book is copyrighted material. Use, reproduction or copying of it by anyone other than Dixon® is strictly forbidden without its express written consent.

NOTE: Reasonable care has been taken in preparing this catalog. Dixon Valve & Coupling Company, LLC reserves the right to make corrections.

