

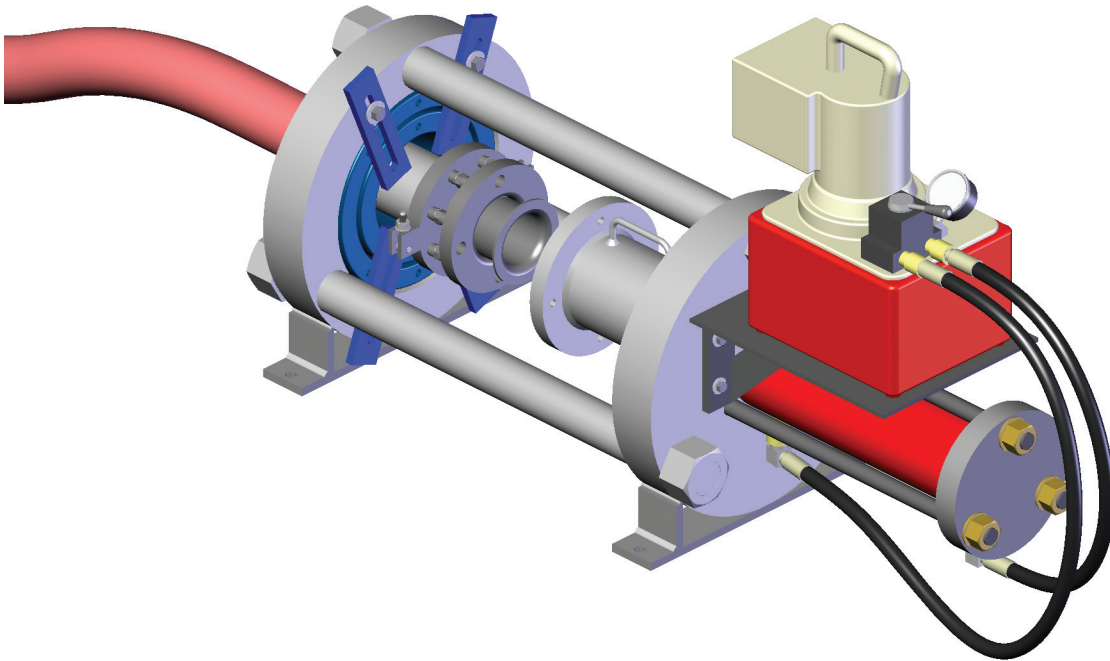

The Right Connection®

Section 3

**50 Ton Ram Operating Instructions
for
1¼" through 4" Standard & Long
Flanged Holedall™ Swaged Couplings
Using Collar with Jack Screws**



Dixon
800 High Street • Chestertown, MD 21620
ph: 877.863.4966 fax: 800.283.4966
dixonvalve.com

! Any coupling assembly (welding of stem, stub end, flange, etc.) must be done prior to starting this procedure. Failure to do so (i.e. welding flange to stem after the swage) can result in serious structural damage to the hose and premature assembly failure.

1a

Install the 6" main pusher (**MPUSH600**) by sliding it onto the rod cap of the ram cylinder. Make sure that the pusher is all the way on the rod cap.

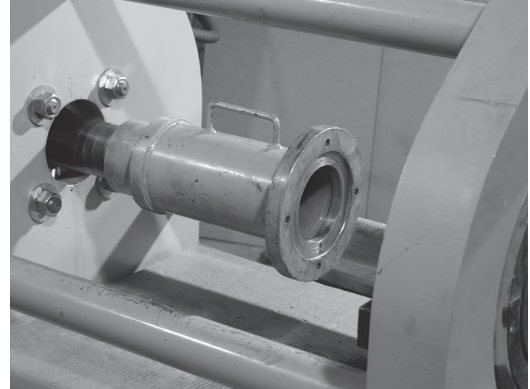

1b

For 1¼" - 4" couplings insert the appropriate size adapter pusher into the 6" main pusher (**MPUSH600**).

For example:
Shown here is the 2" adapter pusher (**50TPUSH200**) being inserted.

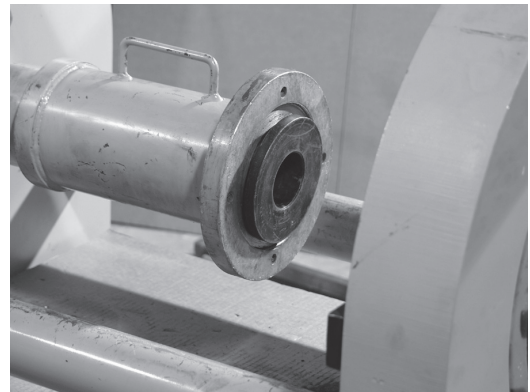

2

Accurately measure the hose O.D. with a diameter tape. Each end of the hose should be measured to guarantee the correct ferrule and die selection. Select the correct ferrule and die based upon the hose free O.D. just measured from the die chart.



3

Assuring that the hose end is cut square, chamfer the I.D. of the hose ⅛" at a 45° angle. This will aid in stem insertion. If the hose is to be static grounded, follow hose manufacturers procedure for proper static grounding.



4



Lubricate the I.D. of the hose and the O.D. of the stem with Dixon Coupling Lubricant or equivalent. Insert the stem into the hose until the hose end contacts the stem collar. Position the sight hole on the ferrule so that this can be observed. After stem insertion, slide the ferrule down until the turned-over part of the ferrule contacts the stem collar.

5a

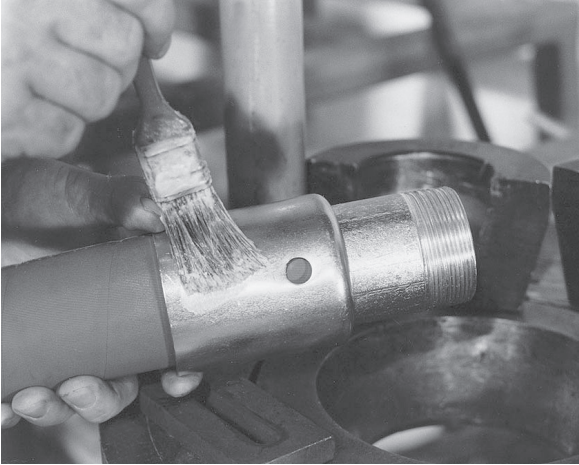

Lubricate the outside of the ferrule with Crisco® (recommended) or high viscosity oil or heavy duty grease.

5b



Lubricate the I.D. of both die halves with Crisco® (recommended) or high viscosity oil or heavy duty grease.

6a

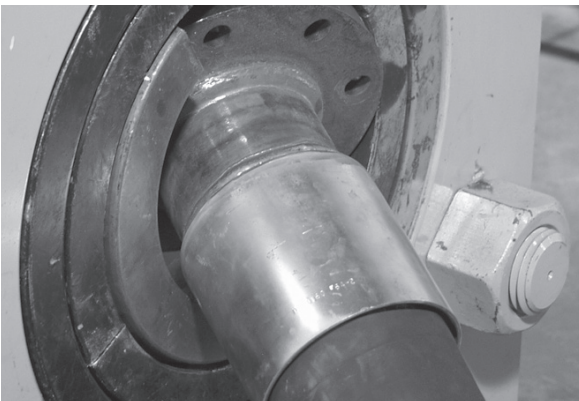

Install the required die holders ensuring that the seams between the die holder halves do not line up. The die holders are designed to fit one inside the other.

A guideline for selecting die holders is:

50TDH6003 1¼" - 3" I.D. hose

50TDH9004 4" - 6" I.D. hose

Caution! Never use a swaging die as a die holder!

6b

Secure the die holders with tie down bars to prevent the die holders from slipping out of the die bed unexpectedly.

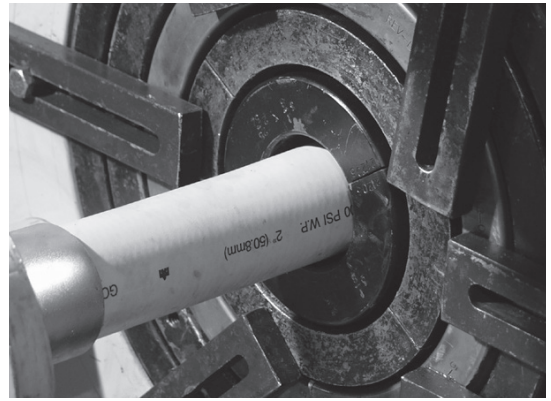
**7**

Bring the hose with the stem and ferrule through the die bed. Insert the stem into the pusher so that the ferrule contacts the pusher. Make sure that there is sufficient room between the die holders and the end of the ferrule to comfortably insert the die halves into the die holders.

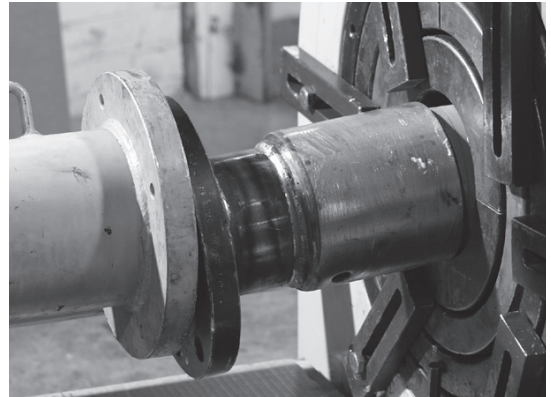
**8a**

Ensuring that all of the jackscrews have been threaded completely into the collar, install the collar with jackscrews between the ferrule and the flange. Position it so that the flat side of the collar is next to the ferrule and the jackscrews are closest to the flange lining up with the bolt holes. Secure both collar halves with the "T" bolt.

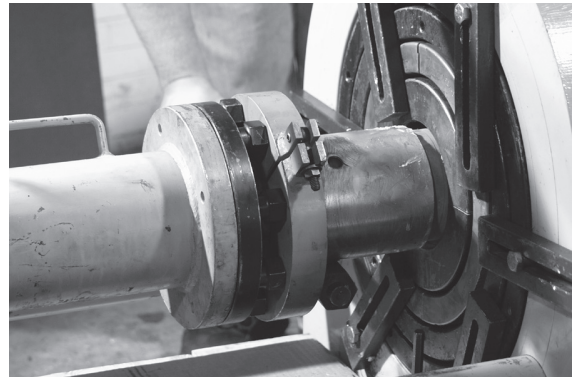
**8b**

Extend all of the jackscrews so that they are contacting the flange. With a wrench, tighten one jackscrew one half turn. Moving to the jackscrew opposite of the one just tightened, tighten it one half turn. Moving to the jackscrew immediately to the right of the first one tightened, tighten it one half turn. Moving to the jackscrew opposite of the one just tightened, tighten it one half turn. Keep repeating this process until all jackscrews are evenly tensioned.

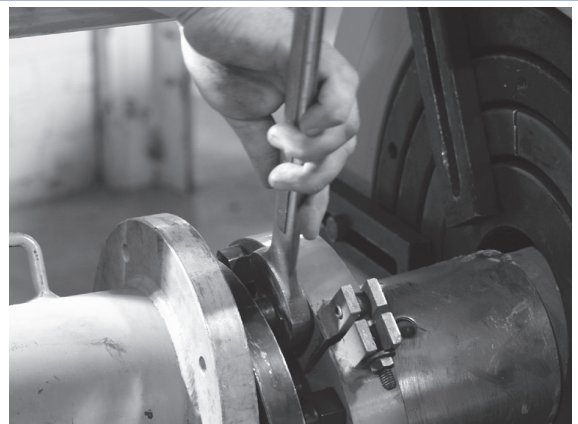

9a

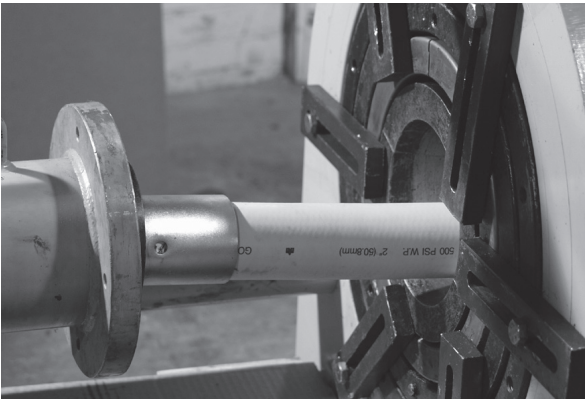

Lifting up the hose, insert one die half under the hose. Lower the hose so that it rests on the die. Insert the other die half. Make sure that the seams of the die do not line up with the seams on the die holders.

9b

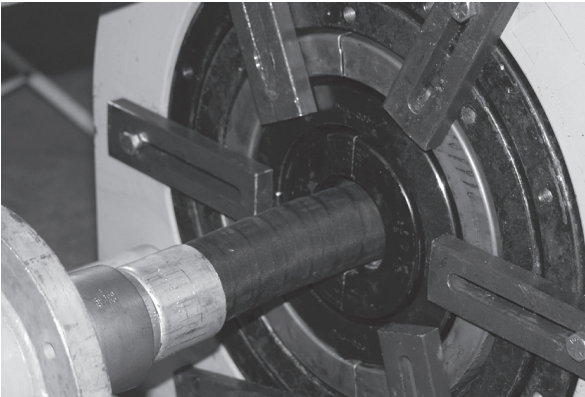

While holding the die in place with one hand, place one of the tie down bars over the die so that it does not come out of the die holder unexpectedly. Secure the tie down bar by tightening the bolt.

10a

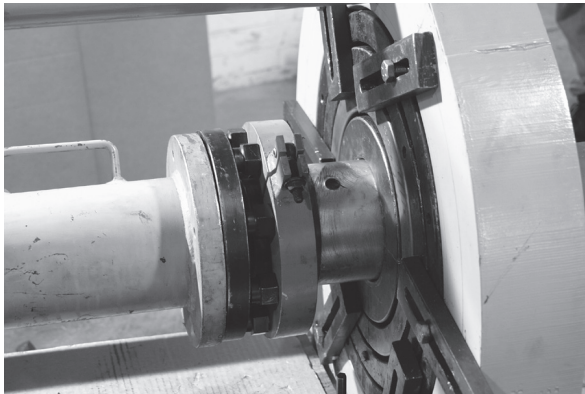

Move the directional control lever to the "Forward" position and depress the button on the remote. Advance the cylinder forward until the end of the ferrule is near the die opening. Using a wooden board or metal pipe, lift the ferrule up. Jog the cylinder by depressing and releasing the button on the remote. This will allow the ferrule to enter the die slowly. After the ferrule has entered the die, stop advancing the cylinder.

10b

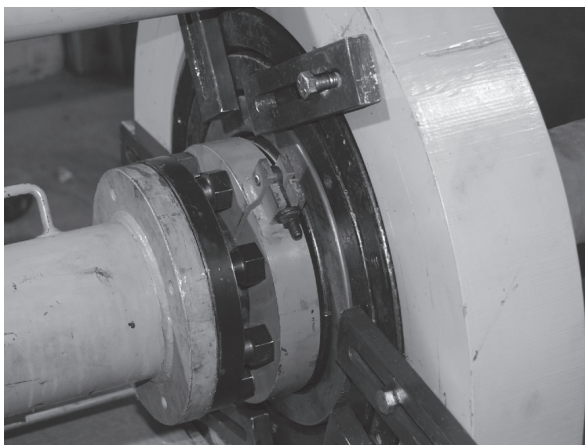

Align the flange face with the pusher. For 4" assemblies, the raised face on the flange will fit into the recess of the Main Pusher (50T-009). For 1-1/4" - 3" assemblies ensure the flange face and the pusher are flush.

11a

Loosen the bolt on the tie down bar holding the die in place. Move the tie down bar so that it clears the collar. When this is done, snug the bolt on that tie down bar.

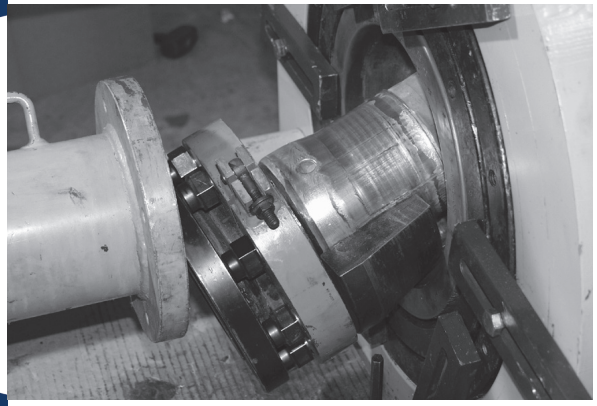

11b

Depress and hold the button on the remote until the top of the ferrule (where welded to stem) is even (flush) with the top of the die. Release the button. Return the directional control lever to the "NEUTRAL" position.

Note: If the gauge reads 10,000 PSI before swaging is complete, stop. The ferrule or die used for that hose end may be incorrect. Contact Dixon for further assistance.

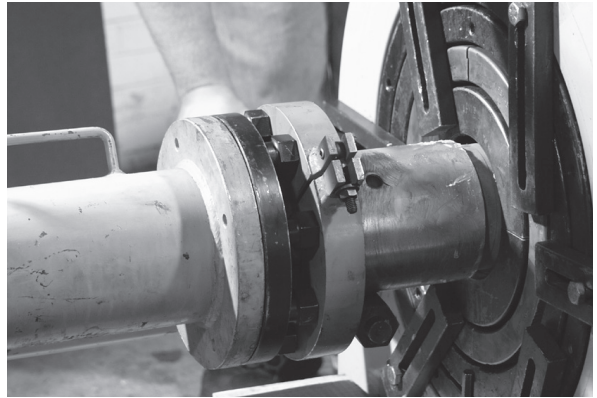

12

Loosen all of the jackscrews so that they clear the flange. Loosen the nut on the "T" bolt so that the "T" bolt moves easily out of its slot. Remove the collar from between the flange and the ferrule.

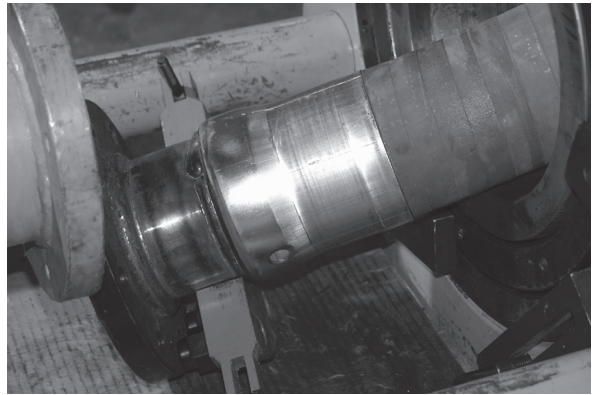

13a

Position a rubber sheet or pad under the die bed. *Slowly* slide the hose towards the pusher. When the die clears the die holder, one or both halves may fall to the floor. If one half remains on the ferrule, tap it with a mallet until it releases. If both halves remain on the ferrule, it may require the halves be pried apart at the seam.

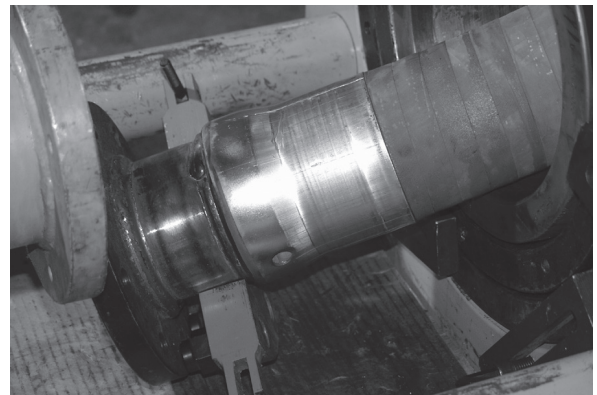

13b

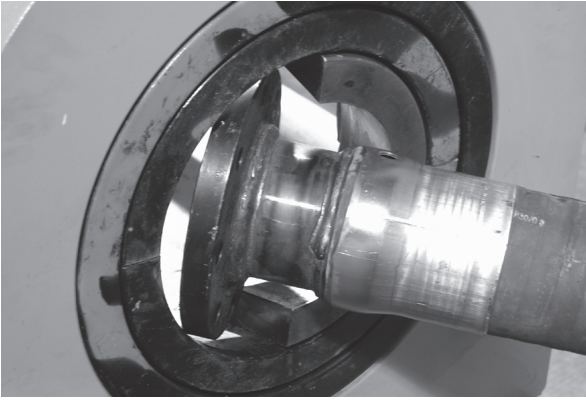

Loosen the bolt(s) on the tie down bar(s) and move the tie down bar(s) so that they clear one die bed spacer. Tighten any bolt just loosened. Remove the die bed spacer one half at a time. Repeat this process for each die bed spacer to be removed. Remove only enough die bed spacers to allow the flange to pass through.

13c



Wipe excess lubricant from hose and ferrule. Bring hose with stem and ferrule back through die bed.